

Compact Ejectors X-Pump SXPi / SXMPi with IO-Link

Suction rate from 185 l/min to 220 l/min

Class A



Suitability for industry specific applications



Compact Ejectors X-Pump SXPi / SXMPi with IO-Link Class A

Application

- High performance vacuum generator for handling suction tight workpieces under extreme conditions, e.g. in vacuum systems in press lines for handling metal sheets
- Pick and place applications with short cycle times
- In automated systems for preparation and precise monitoring of the vacuum system

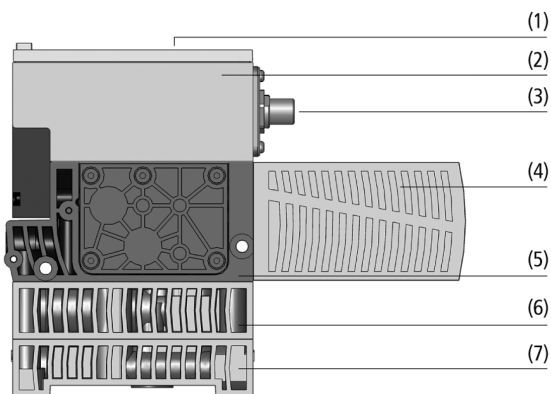

Design

- User display (1) with large scale operating and display elements
- Control electronics (2) with diverse monitoring functions
- Electrical connection (3) via standard M12 plug
- Removable silencer (4)
- Main body (5) made of extremely robust plastic, compact ejector SXMPi is additionally equipped with the power blow off module (6)
- Horizontal connection plate with vacuum and compressed air connection (7); optional with quick change adapter

System design Compact Ejectors X-Pump SXPi / SXMPi with IO-Link Class A



Central vacuum generation by compact ejectors X-Pump SXPi / SXMPi

Product highlights

- Communication of process and status data via IO-Link
- Integrated air saving function reduces energy consumption to a minimum
- Condition monitoring for process and plant monitoring reduces downtime and errors
- Voltage regulator ensures a constant voltage
- Pressure monitoring optionally provides additional information about the operating status

Compact Ejectors X-Pump SXPi / SXMPi with IO-Link

Suction rate from 185 l/min to 220 l/min

Class A

Designation code Compact Ejectors X-Pump SXPi / SXMPi with IO-Link Class A

SXMPi	–	25	–	NC	–	H	–	PC	–	2xM12-5
1		2		3		4		5		6

1 – Abbreviated designation

Code	Version
SXPi	Without power blow off
SXMPi	With power blow off

2 – Nozzle size

Code	Diameter in mm
25...30	ø 2.5 and 3

3 – Idle position suction valve

Code	Type
IMP	Bistable switched with pulse
NC	Normally closed
NO	Normally open

4 – Connection pneumatical

Code	Connection
H	Horizontal
Q	Quick change

5 – Additional function

Code	Type
PC	Pressure monitoring

6 – Connection electrical

Code	Connection
M12-8	M12, 8-pole
2xM12-5	2xM12, 5-pole

Compact ejector SXPi / SXMPi is delivered as a ready-to-connect product (without connection cable).

























Available spare parts: connection cable, base plate, ejector tester



































Compact Ejectors X-Pump SXPi / SXMPi with IO-Link

Suction rate from 185 l/min to 220 l/min

Class A

Ordering data Compact Ejectors X-Pump SXPi / SXMPi with IO-Link Class A

Type				Nozzle size:	
				25	30
SXPi	IMP	H	M12-8	10.02.02.03792 	10.02.02.03796 
SXPi	IMP	Q	M12-8	10.02.02.03793 	10.02.02.03797 
SXPi	IMP	H	2xM12-5	10.02.02.03794 	10.02.02.03798 
SXPi	IMP	Q	2xM12-5	10.02.02.03795 	10.02.02.03799 
SXPi	NC	H	M12-8	10.02.02.03784 	10.02.02.03788 
SXPi	NC	Q	M12-8	10.02.02.03785 	10.02.02.03789 
SXPi	NC	H	2xM12-5	10.02.02.03786 	10.02.02.03790 
SXPi	NC	Q	2xM12-5	10.02.02.03787 	10.02.02.03791 
SXPi	NO	H	M12-8	10.02.02.03776 	10.02.02.03780 
SXPi	NO	Q	M12-8	10.02.02.03777 	10.02.02.03781 
SXPi	NO	H	2xM12-5	10.02.02.03778 	10.02.02.03782 
SXPi	NO	Q	2xM12-5	10.02.02.03779 	10.02.02.03783 

Type					Nozzle size:	
					25	30
SXMPi	IMP	H	-	M12-8	10.02.02.03816 	10.02.02.03820 
SXMPi	IMP	H	PC	M12-8	-	10.02.02.04561 
SXMPi	IMP	Q	-	M12-8	10.02.02.03817 	10.02.02.03821 
SXMPi	IMP	H	-	2xM12-5	10.02.02.03818 	10.02.02.03822 
SXMPi	IMP	H	PC	2xM12-5	10.02.02.04022 	10.02.02.04097 
SXMPi	IMP	Q	-	2xM12-5	10.02.02.03819 	10.02.02.03823 
SXMPi	IMP	Q	PC	2xM12-5	10.02.02.04563 	10.02.02.03731 
SXMPi	NC	H	-	M12-8	10.02.02.03808 	10.02.02.03812 
SXMPi	NC	H	PC	M12-8	10.02.02.04189 	-
SXMPi	NC	Q	-	M12-8	10.02.02.03809 	10.02.02.03813 
SXMPi	NC	Q	PC	M12-8	10.02.02.04025 	-
SXMPi	NC	H	-	2xM12-5	10.02.02.03810 	10.02.02.03814 
SXMPi	NC	H	PC	2xM12-5	10.02.02.04021 	-
SXMPi	NC	Q	-	2xM12-5	10.02.02.03811 	10.02.02.03815 
SXMPi	NC	Q	PC	2xM12-5	10.02.02.04024 	-
SXMPi	NO	H	-	M12-8	10.02.02.03800 	10.02.02.03804 
SXMPi	NO	Q	-	M12-8	10.02.02.03801 	10.02.02.03805 
SXMPi	NO	H	-	2xM12-5	10.02.02.03802 	10.02.02.03806 
SXMPi	NO	H	PC	2xM12-5	10.02.02.04023 	-
SXMPi	NO	Q	-	2xM12-5	10.02.02.03803 	10.02.02.03807 

Ordering data Accessories Compact Ejectors X-Pump SXPi / SXMPi with IO-Link Class A

Type		Part no.
Connection cable, M12 8-pole, 5 m, PUR, straight	ASK B-M12-8 5000 K-8P	21.04.05.00079
Connection cable, M12 5-pole, 5 m, PUR, straight	ASK B-M12-5 5000 K-5P	21.04.05.00080
Connection cable, M12 8-pole, M12 4-pole, 1 m, PUR, straight	ASK B-M12-8 1000 S-M12-4	21.04.05.00167
Basic plate	GPQ1 122x46x43 SXPi/SXMPi	10.02.02.02473
Basic plate	GPQ2 122x87x48 SXPi/SXMPi	10.02.02.02154
Ejector tester	EJEK-TEST SMPi/SCPi	10.02.02.03588

Compact Ejectors X-Pump SXPi / SXMPi with IO-Link

Suction rate from 185 l/min to 220 l/min

Class A

Technical data Compact Ejectors X-Pump SXPi / SXMPi with IO-Link Class A

Type*	Nozzle diameter [mm]	Degree of evacuation [%]	Suction rate (max.) [l/min]	Suction rate (max.) [m³/h]	Air consumption suction [l/min]**	Air consumption suction [m³/h]***	Max. air consumption blow-off [l/min]
SXPi	2.5	85	185	11.1	290	17.4	200
SXPi	3.0	85	220	13.2	380	22.8	200
SXMPi	2.5	85	185	11.1	290	17.4	320
SXMPi	3.0	85	220	13.2	380	22.8	320

*The supply voltage for vacuum switches and solenoid valves is 24V DC

**At optimal operating pressure (4.5 bar)

***At optimal operating pressure (4.5 bar)

Type*	Sound pressure level free [dB(A)]	Pressure range (operating pressure) [bar]	Recommended hose internal diameter compressed air [mm]**	Recommended hose internal diameter vacuum [mm]***	Weight [kg]	Operating temperature [°C]
SXPi	67	3.0 ... 6.0 bar	8	9	0.77	0 ... 50 °C
SXPi	72	3.0 ... 6.0 bar	8	9	0.77	0 ... 50 °C
SXMPi	67	3.0 ... 6.0 bar	8	9	0.91	0 ... 50 °C
SXMPi	72	3.0 ... 6.0 bar	8	9	0.91	0 ... 50 °C

*The supply voltage for vacuum switches and solenoid valves is 24V DC

**For max. length 2 m

***For max. length 2 m

Compact Ejectors X-Pump SXPi / SXMPi with IO-Link

Suction rate from 185 l/min to 220 l/min
Class A

Performance data Compact Ejectors X-Pump SXPi / SXMPi with IO-Link Class A

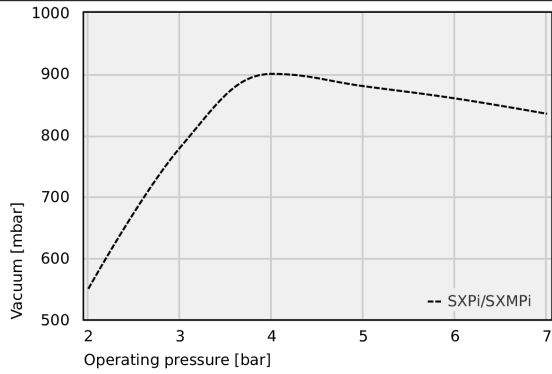

Achievable vacuum at various operating pressures

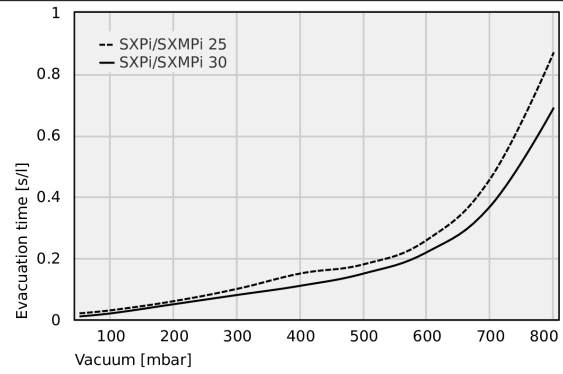

Evacuation time for various vacuum ranges [s/l]

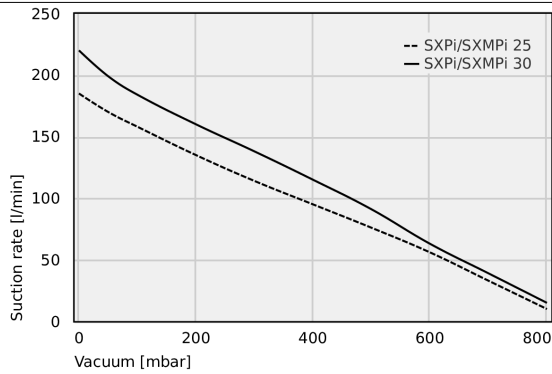

Suction rate at various degrees of evacuation [l/min]

Achievable vacuum at various operating pressures

	2	3	4	5	6	7
SXPi/SXMPi	550.00	780.00	900.00	880.00	860.00	835.00

Compact Ejectors X-Pump SXPi / SXMPi with IO-Link

Suction rate from 185 l/min to 220 l/min

Class A

📄 Evacuation time for various vacuum ranges [s/l]

	50	100	200	300	400	500	600	700	800
SXPi/SXMPi 25	0.02	0.03	0.06	0.10	0.15	0.18	0.26	0.46	0.87
SXPi/SXMPi 30	0.01	0.02	0.05	0.08	0.11	0.15	0.22	0.37	0.69

📄 Suction rate at various degrees of evacuation [l/min]

	0	50	100	200	300	400	500	600	700	800
SXPi/SXMPi 25	185.00	170.00	158.00	135.00	114.00	95.00	76.00	56.00	33.00	10.00
SXPi/SXMPi 30	220.00	199.00	184.00	160.00	138.00	115.00	91.00	63.00	39.00	15.00

Compact Ejectors X-Pump SXPi / SXMPi with IO-Link

Suction rate from 185 l/min to 220 l/min

Class A

Design data Compact Ejectors X-Pump SXPi / SXMPi with IO-Link Class A

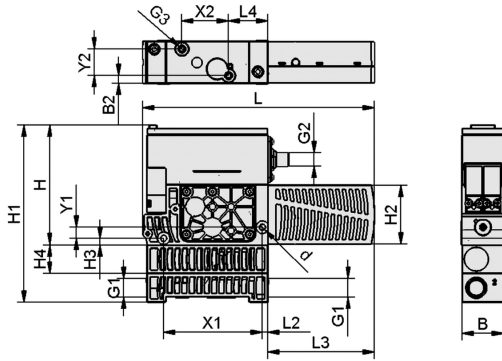

SX(M)Pi H

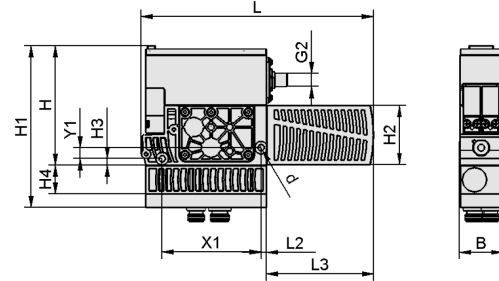

SX(M)Pi Q

Compact Ejectors X-Pump SXPi / SXMPi with IO-Link

Suction rate from 185 l/min to 220 l/min

Class A

Design data Compact Ejectors X-Pump SXPi / SXMPi with IO-Link Class A

Type		B [mm]	B2 [mm]	d [mm]	G1	G2	G3	H [mm]	H1 [mm]	H2 [mm]	H3 [mm]	H4 [mm]	L [mm]	L2 [mm]	L3 [mm]	L4 [mm]	X1 [mm]	X2 [mm]	Y1 [mm]	Y2 [mm]
SXPi	H	39	6.8	5.5	G3/8"-F	M12x1-M	M5-F	108	134	54	6	-	210	5	97	35.5	89	42	10	24
SXPi	Q	39	-	5.5	-	M12x1-M	-	108	120	54	6	-	210	5	97	-	89	-	10	-
SXMPi	H	39	6.8	5.5	G3/8"-F	M12x1-M	M5-F	108	160	54	6	26	210	5	97	35.5	89	42	10	24
SXMPi	Q	39	-	5.5	-	M12x1-M	-	108	146	54	6	26	210	5	97	-	89	-	10	-

Multimedia product presentation

Medium

Product video

Link

<https://vimeo.com/147436675>