



EN

## Operating Instructions Vacuum unit VAGG 18

**Please note**

These operating instructions were prepared in German.  
Store for future use.

Subject to technical changes, typographical and other errors.

**Publisher**

© J. Schmalz GmbH, 12.2016

This document is protected by copyright law. All resulting rights remain the property of J. Schmalz GmbH. The reproduction of the document or parts thereof is only permitted within the legal restrictions established by copyright law. Any amendment or abridgement of the document is prohibited without the express written consent of J. Schmalz GmbH.

**Contact**

J. Schmalz GmbH  
Aacher Straße 29  
D-72293 Glatten

Tel. +49 (0)7443 2403-0  
Fax +49 (0)7443 2403-259  
schmalz@schmalz.de  
www.schmalz.com

You can find contact information on the Schmalz companies and trading partners worldwide at  
 [www.schmalz.com/vertriebsnetz](http://www.schmalz.com/vertriebsnetz)

1	Safety information .....	5
1.1	Classification of the safety information .....	5
1.2	Warnings.....	6
1.3	Mandatory action signs.....	6
1.4	General safety information .....	7
1.5	Intended use .....	9
1.6	Incorrect use .....	9
1.7	Requirements and information relating to the installation, maintenance and operating personnel .....	9
1.8	Reference to specific dangers .....	11
2	Product Description .....	12
2.1	Components of the vacuum unit.....	12
2.2	General description of the functions .....	12
3	Technical Data .....	14
3.1	General parameters.....	14
3.2	Dimensions .....	14
3.3	Electrical output for machine release .....	15
4	Delivery, Packaging and Transport .....	15
4.1	Delivery.....	15
4.1.1	Scope of delivery .....	15
4.1.2	Check integrity .....	15
4.1.3	Report damage .....	15
4.2	Packaging .....	16
4.3	Transport and assembly .....	16
4.3.1	Shipment.....	16
4.3.2	Assembly .....	16
5	Commissioning.....	17
5.1	Installation.....	17
5.1.1	Electrical connection.....	17
5.1.2	Vacuum connection .....	18
5.1.3	Connecting the signal generating electrical cable to the machine .....	18
5.1.4	Checking the operating vacuum .....	19
5.1.5	Acoustic warning device and output for machine release .....	19
5.1.6	Fill level monitor for the liquid separator.....	20
5.1.7	Energy saving function .....	20
6	Operation.....	21
6.1	Connecting to a clamping device .....	21
6.2	Emptying the liquid storage chamber .....	22
6.3	Description of the functions .....	23
6.3.1	Vacuum monitoring.....	23
6.3.2	Fill level monitor for the liquid separator.....	24

7	Troubleshooting.....	26
8	Maintenance.....	27
8.1	General safety information .....	27
8.2	Pump oil maintenance .....	27
8.2.1	Separate pump oil from condensed liquids .....	28
8.2.2	Oil quantity and oil change .....	28
9	Warranty, Spare and Wear Parts .....	29
9.1	Warranty .....	29
9.2	Spare and wear parts .....	29
10	Accompanying documents .....	29
10.1	Vacuum pump operating instructions .....	29
10.2	Declaration of Conformity .....	29

# 1 Safety information

## 1.1 Classification of the safety information

### Danger

This warning warns of danger that will result in death or serious injuries if it is not avoided.

 <b>DANGER</b>	
	<b>Type and source of the danger</b> Consequences of the danger ▶ Removing the danger

### Warning

This warning warns of danger that may result in death or serious injuries if it is not avoided.

 <b>WARNING</b>	
	<b>Type and source of the danger</b> Consequences of the danger ▶ Removing the danger

### Caution

This warning warns of danger that may result in injuries if it is not avoided.

 <b>CAUTION</b>	
	<b>Type and source of the danger</b> Consequences of the danger ▶ Removing the danger

### Attention

This warning warns of danger that may result in property damage if it is not avoided.

<b>ATTENTION</b>	
	<b>Type and source of the danger</b> Consequences of the danger ▶ Removing the danger

### General information







This symbol is used if important information on handling the machine/system/unit is provided.



Note / Information







## 1.2 Warnings

Explanation of the warning signs used in these operating instructions.



Icon	Description	Icon	Description
	General warning		Warning of hot surface
	Warning of electrical voltage		Warning of flying parts
	Warning of vacuum		Warning of environmental damage



## 1.3 Mandatory action signs









Explanation of the mandatory action signs used in these operating instructions.

Icon	Description	Icon	Description
	Follow the operating instructions		Wear safety boots
	Wear gloves		Remove mains plug
	Wear face mask		Wear eye protection
	Disconnect prior to maintenance or repair		

## 1.4 General safety information

 <b>WARNING</b>	
 	<p><b>Risk of injury as a result of non-compliance with the general Safety information</b></p> <p>Leads to personal injury and damage to the system</p> <ul style="list-style-type: none"> <li>▶ The operating instructions contain important information on handling the vacuum unit. Read these operating instructions carefully and store them for future use.</li> <li>▶ The operating instructions are aligned to the equipment delivered by Schmalz. Customer changes to the system are not taken into account and are generally prohibited!</li> <li>▶ The vacuum unit may only be connected and commissioned once the operating instructions have been read and understood!</li> <li>▶ Unauthorised conversions and changes to the vacuum unit are prohibited for reasons of safety! General safety regulations, EN standards and VDE guidelines must be complied with!</li> <li>▶ The operating instructions must be stored with the machine. All persons performing activities on the machine must be able to consult the operating instructions at all times.</li> <li>▶ Instruction manuals within the meaning of the Occupational Health and Safety Act and the Equipment Usage Directive must be provided in addition to the operating instructions (machine control switching function).</li> <li>▶ In particular, the operator must ensure that additional risks, which arise due to the special operating conditions at the place of operation and the integration of the vacuum unit into a machine pursuant to Machinery Directive 2006/42/EC, are determined in a risk analysis (within the meaning of § 5 of the Occupational Health and Safety Act).</li> <li>▶ The components must generally be protected against damage of any kind!</li> </ul>

 <b>WARNING</b>	
 	<p><b>Risk of injury from vacuum and high volume flow</b></p> <p>Hair, skin, body parts and items of clothing will be sucked in.</p> <ul style="list-style-type: none"> <li>▶ Wear close-fitting clothing and safety goggles.</li> <li>▶ Use a hair net.</li> <li>▶ Do not look or reach into the vacuum connection.</li> <li>▶ Ensure that the suction opening is kept away from body orifices.</li> </ul>

 <b>CAUTION</b>	
	<p><b>Risk of burns from coming into contact with a vacuum pump in continuous operation</b></p> <p>Burns to the skin</p> <ul style="list-style-type: none"> <li>▶ Keep a safe distance away from the vacuum pump and do not touch hot surfaces.</li> <li>▶ Only perform maintenance work after allowing for a 1h cooling period.</li> </ul>
 <b>CAUTION</b>	
	<p><b>Risk of eye injuries</b></p> <p>All vacuum generators generate an exhaust air flow. Depending on the purity of the ambient air, this may contain exhaust gas particles that pass out of the exhaust opening at high speed and cause face and eye injuries.</p> <ul style="list-style-type: none"> <li>▶ Keep away from the exhaust airflow.</li> <li>▶ Wear safety goggles.</li> </ul>
 <b>CAUTION</b>	
	<p><b>Risk of eye and airway injuries</b></p> <p>The vacuum pump exhaust gases may form aerosols (air-particle mixtures) that may result in eye and airway injuries.</p> <ul style="list-style-type: none"> <li>▶ Wear a face mask.</li> <li>▶ Wear safety goggles.</li> </ul>
 <b>CAUTION</b>	
	<p><b>Risks of using the vacuum clamping system as part of an integrated system at the operating site</b></p> <p>Property damage and/or personal injury</p> <ul style="list-style-type: none"> <li>▶ Prepare a risks analysis for the entire system with regard to the vacuum clamping system.</li> </ul>



## 1.5 Intended use

The vacuum unit is intended to control and maintain a specific vacuum and act as a liquid separator. Appropriate safety precautions on systems and units that are used in connection with the vacuum unit must prevent any risks to individuals, animals or property as a result of a loss of operating vacuum. A machine or system pursuant to Machinery Directive 2006/42/EC with the relevant safety installations is required in order to use the vacuum unit.

The product is intended for industrial application.

Compliance with the technical data and the assembly and operating information provided in these operating instructions as well as with the maintenance intervals are part of the product's intended use.

The vacuum unit is exclusively intended to control and maintain a specific operating vacuum that is used to fasten certain workpieces to an appropriate vacuum clamping device on a CNC machining centre.

Vacuum units are perfectly designed to evacuate media with a liquid content and can also be used for CNC machining centres that operate with coolants or lubricants.

## 1.6 Incorrect use

The vacuum unit is not intended to suck in body parts and other living creatures. The evacuation of items with an implosion risk and unauthorised media is prohibited in any form. The vacuum unit is not designed for mechanical loads of any kind.

Unauthorised conversions and changes to the vacuum unit are prohibited for reasons of safety!

Any other use that deviates from the intended use is not permitted and may lead to dangerous situations!

## 1.7 Requirements and information relating to the installation, maintenance and operating personnel

The vacuum unit was designed and constructed in consideration of a risk analysis and with application and compliance to the relevant harmonised standards, as well as additional technical specifications. This represents a state-of-the-art design and ensures maximum safety.



However, this level of safety can only be reached in practice if all the necessary measures have been taken. The company operating the vacuum unit has a duty of care to plan these measures and control their implementation.

The vacuum unit may only be installed and maintained by qualified experts, mechanics and electricians. All activities associated with the product require fundamental mechanical and pneumatic knowledge as well as knowledge of the related technical terms. Work on the electronics may generally only be performed by electricians.

*"An expert is any individual whose technical training, knowledge and experience as well as their knowledge of the applicable provisions allows them to assess the activities assigned to them, identify possible risks and take appropriate safety measures. An expert must comply with the applicable technical regulations."*



Any individual assigned to set up, commission, operate, maintain and repair the vacuum unit in the operating company must have read and understood the operating instructions.

 <b>DANGER</b>	
 	<p><b>Electric shock from contacting live parts</b></p> <p>Risk of death due to electric shock</p> <ul style="list-style-type: none"> <li>▶ Work on the electrical installation may only be performed by an electrician.</li> <li>▶ Disconnect the electrical energy supply prior to assembly, adjustment and maintenance activities and secure against restart.</li> <li>▶ Ensure that the power has been disconnected, earth and short-circuit.</li> <li>▶ Do not connect or disconnect a live mains plug.</li> </ul>

The operating company must introduce internal measures to ensure that:

1. the vacuum unit is only used as intended.
2. the vacuum unit is only operated in a flawless and functional state and that, in particular, the functionality of the safety installations is reviewed on a regular basis.
3. the operating instructions are always complete and available in a legible condition at the machine's operating location.
4. only qualified and authorised personnel operate, maintain and repair the vacuum unit.
5. the operating personnel are regularly instructed on all issues of occupational health and safety and environmental protection and that they are familiar with the operating instructions and particularly the relevant safety information.

The responsibilities for the various activities on the unit must be clearly defined and complied with. No ambiguous competencies are permitted.

## 1.8 Reference to specific dangers

Before starting the vacuum unit make sure that you are familiar with:



1. the specific features of the vacuum unit,
2. the machine equipment,
3. the operation of the vacuum unit,
4. the immediate environment in which the vacuum unit and the machine or system with which the vacuum unit is used, is located,
5. the machine's safety installations,
6. the measures in case of emergency.

The following activities must be performed before starting:

1. Check and ensure that all safety installations have been attached and are functioning.
2. Check the vacuum unit for visible damage and immediately remove identified defects or report these to the supervisor.
3. The vacuum unit and the machine may only be operated in a flawless condition.
4. Check and ensure that only authorised individuals are located in the machine's or the system's area of operation and that no other individuals are placed at risk by switching on the machine.

The workpiece being machined on the machine table or in the system may shift or even be released in the following circumstances:

- Power failure,
- Pump failure and
- Line break.

 <b>CAUTION</b>	
	<p><b>Danger from unexpected malfunctions</b> Property damage and/or personal injury</p> <ul style="list-style-type: none"> <li>▶ Restart the workpiece clamping process from the very beginning after a failure or disruption of the vacuum supply system.</li> <li>▶ Restore the vacuum supply and</li> <li>▶ Check the system for existing software errors (machine control switching functions)</li> </ul>

## 2 Product Description

### 2.1 Components of the vacuum unit



Item	Description
1	Manual discharge valve with hose fitting
2	Vacuum chamber / liquid separator
3	Vacuum manometer
4	Manual lever valve (vacuum ON/OFF) with hose fitting
5	Oil inspection glass
6	Inspection glass with float
7	Droplet separator
8	Vacuum pump
9	Handle
10	Manual pressure switch for energy saving function
11	Electrical cabinet
12	Mains switch
13	Interface to the machine

### 2.2 General description of the functions

The vacuum unit is used to control and maintain a specific operating vacuum and as a liquid separator for evacuated liquid media. It was developed specifically for use in combination with vacuum clamping devices and may only be used for this purpose (also refer to Chap. "Intended Use"). The vacuum unit represents the interface between the machine and the clamping device.

The integrated vacuum pump (8) achieves a maximum vacuum of approx. -930 mbar and runs by default in continuous operation. Depending on the conditions such as e.g. the workpiece material, the condition of the seals, etc. to a permanent vacuum between -600 to -930 mbar is set.

Via the interface to the machine (13), the states from the vacuum and from the level of the liquid in a vacuum chamber (2) can be monitored and upon reaching limit values electric signals are output or interrupted.

The media evacuated by the vacuum unit is fed from the clamping device through the vacuum unit. The liquids contained are separated by the vacuum unit and remain in the vacuum chamber (2). The rising liquid level is visually displayed by a float (6). The red area on the float (6) as well as an acoustic warning signal is provided to identify the vacuum chamber's (2) critical fill level. The potential-free contact's machine release is interrupted at the same time.

The liquid collected in the vacuum chamber (2) is manually drained via the discharge valve (1). The vacuum unit must be switched off to drain the liquid (more information on draining is provided in Chap. 6.2).

The vacuum unit is equipped with an energy saving function. This function is activated by the actuation of the pressure switch (10) and controlled by the integrated vacuum sensor.

The vacuum pump (8) is switched off when it reaches -800 mbar vacuum. If the vacuum by leaks in the vacuum system drops below a vacuum of -700 mbar, the vacuum pump (8) is switched on automatically.

The operation of VAGG in the energy saving mode is allowed at a start frequency  $\leq 10$  starts / hour. At a higher starting frequency the VAGG shall be operated in continuous operation.

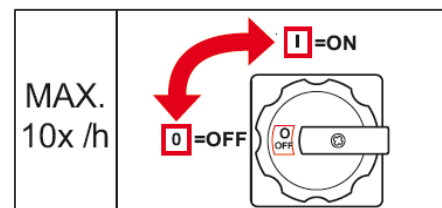

### 3 Technical Data

<b>ATTENTION</b>	
	<p><b>Non-compliance with the vacuum unit's performance limits</b></p> <p>The vacuum unit and connected components may malfunction or be damaged.</p> <p>▶ Only operate the vacuum unit within the specified performance limits</p>

#### 3.1 General parameters

Parameter	18-L
Pump type	EVE-OG 18
Max. vacuum [mbar]	930
Storage volume [L]	30
Suction capacity at 50 Hz [m³/h]	18
Voltage at 50 Hz [V]	175-260 / 300-450
Current range at 50 Hz [A]	3.3 / 1.95
Noise level at 50 Hz [db/A]	63
Weight [kg]	60
Oil quantity [l]	1.0

#### 3.2 Dimensions

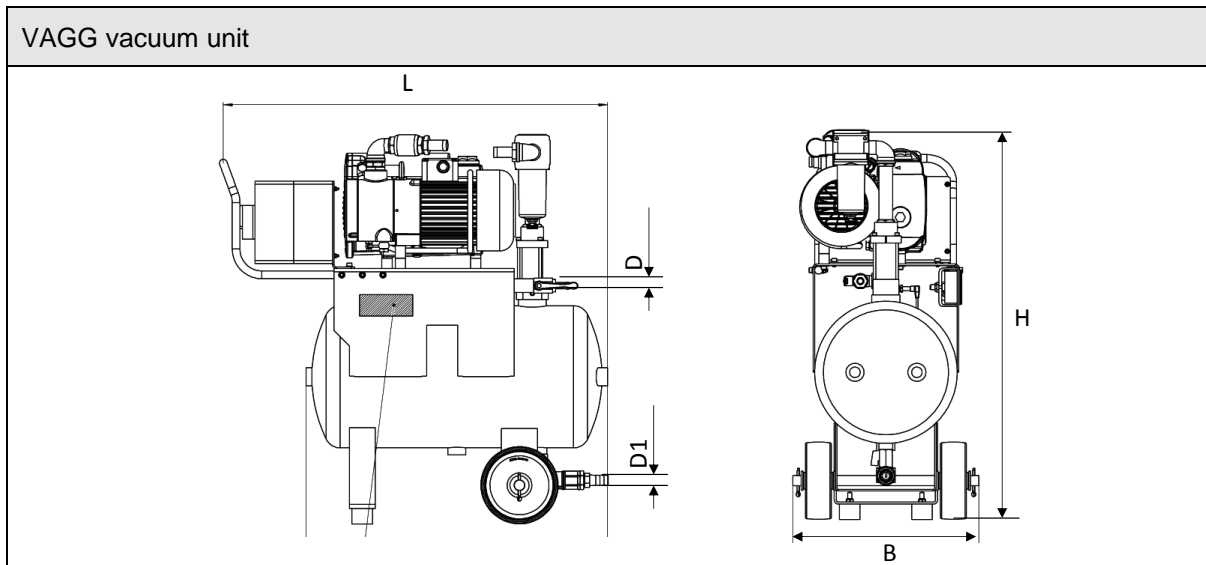

Type	L [mm]	W [mm]	H [mm]	D [mm]	D1 [mm]
VAGG-18	750	360	760	12	12

### 3.3 Electrical output for machine release

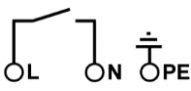
Max. switching voltage	Max. switching current	Pin assignment
24 VDC	1 A	

## 4 Delivery, Packaging and Transport

### 4.1 Delivery

#### 4.1.1 Scope of delivery

The delivery includes an appropriate vacuum hose, 2 m long, and a plug to connect the electrical signal cable.



The precise scope of delivery is provided in the order confirmation.

The weight and dimensions are listed in the delivery notes. This information must be complied with in order to ensure that appropriate means of transport and fastenings are used.



The operating instructions are part of the vacuum unit and must be included as part of any change of location.

#### 4.1.2 Check integrity

Check that everything has been included in the shipment based on the enclosed delivery notes.

#### 4.1.3 Report damage

Damage as a result of defective packaging or transport must be reported to the freight forwarder and J. Schmalz GmbH immediately after receipt of the shipment.

## 4.2 Packaging

 <b>CAUTION</b>	
	<p><b>Knives or other sharp objects may damage hoses or cables</b></p> <p>Malfunctions and leakage</p> <p>▶ Take care when removing the packaging.</p>

The type of packaging depends on the transport route, the product dimensions and the weight of the shipment.

Carefully unwrap the packaging, remove foils, cartons, tensioning straps and packaging timber.



The packaging material must be disposed of in accordance with local laws and directives. Marked transport aids and locks must be removed.

## 4.3 Transport and assembly

### 4.3.1 Shipment

The vacuum unit is shipped upright, lashed to a pallet, ex-factory.

It must always be transported upright (including in-house) as the oil inside the vacuum pump (8) would otherwise leak out.

### 4.3.2 Assembly

The unit may only be assembled by qualified experts.

The vacuum unit is equipped with castors and a handle for transport and assembly. The transport handle allows for flexible transport to the relevant installation location.

Once the unit has been set down on the floor, the flatness and stability must be checked.

The oil in the vacuum pump (8) must be checked using the display on the oil inspection glass (5) and topped-up, if necessary, prior to commissioning.



Commissioning without sufficient oil will result in the failure of the vacuum pump (8).



# 5 Commissioning

The vacuum unit may only be installed by qualified experts, mechanics and electricians. All activities associated with the product require fundamental mechanical and pneumatic knowledge as well as knowledge of the related technical terms.

Work on the electronics may generally only be performed by electricians.

## 5.1 Installation

<b>CAUTION</b>	
	<p><b>Injuries, damage and malfunctions due to incorrect assembly and existing damage</b></p> <p>Personal injury and property damage to the vacuum unit and the entire system</p> <ul style="list-style-type: none"> <li>▶ Visually inspect the vacuum unit for any damage prior to commissioning.</li> <li>▶ Place the vacuum unit on a solid and level surface so that it cannot topple over.</li> </ul>

<b>ATTENTION</b>	
	<p><b>Damage to the vacuum pump (8) when operating without oil</b></p> <p>Damage to the vacuum unit</p> <ul style="list-style-type: none"> <li>▶ Check the oil level in the vacuum pump (8) via the oil inspection window (5) provided prior to commissioning and operating the vacuum unit.</li> </ul>

In case too little oil is in the vacuum pump (8), unscrew the oil filler cap and fill in oil up to the maximum of the oil inspection glass (5).

### 5.1.1 Electrical connection

Power cable and other energy cables must be installed so that they do not present tripping hazards and they must be protected against mechanical damage.

We recommend installing the cables in a closed conduit.

Electrical output data can be found on the pump motor's name plate.

A CEE plug with 5 poles (400 V, 16 A) is used for the connection.

Check the direction of rotation of the vacuum pump (8)

1. Switch on the vacuum unit at the mains switch (12) on the electrical cabinet (11).
2. Pay attention to the direction of rotation of the motor's fan blade on the vacuum pump (8).

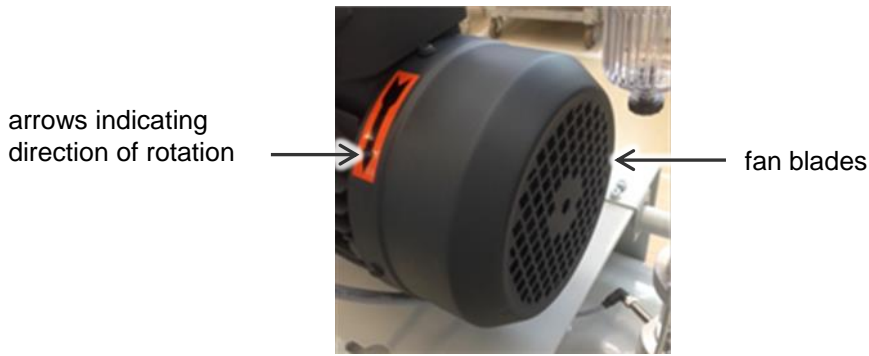

**IMPORTANT:** The prescribed direction of rotation is displayed by an arrow on the motor housing.

3. The unit is shipped with a "clockwise field of rotation"

**IMPORTANT:** Immediately shutdown the vacuum unit if it is rotating in the wrong direction and reverse the polarity of the connection in the mains plug.

4. Check the direction of rotation.

<b>ATTENTION</b>	
	<p><b>The vacuum pump (8) may be damaged if it is operated in the wrong direction of rotation</b></p> <p>Vacuum pump (8) damaged</p> <p>▶ Check the direction of rotation and reverse the polarity of the electrical supply lines if necessary.</p>

5.1.2 Vacuum connection

The vacuum unit must be connected to the clamping device via the vacuum connection (4) using an appropriate vacuum hose (2 m hose is included in the scope of delivery):

- Clamping device/vacuum unit connection hose = Ø12 mm.  
Hose for vacuum and compressed air systems VSL 21-12 PVC-G

5.1.3 Connecting the signal generating electrical cable to the machine

Connecting the vacuum unit to the machine's control unit provides additional safety. With the accompanying plug (scope of the delivery) the vacuum unit has to be connected to the control of the entire machine.

Via the interface to the machine (13), the states from the vacuum and from the level of the liquid in a vacuum chamber (2) can be monitored and upon reaching limit values electric signals are emitted or interrupted.

The potential-free contact (13) (break contact) connection is located in the electrical cabinet (11).

The circuit diagram for the vacuum unit is located in the electrical cabinet (11).

1. Connect a three wire cable (connection L, connection N and protective conductor) to the enclosed multi-pole plug.



Plug STEK 3 FZ M25 20

2. Check the switching operation with a continuity tester (between L and N) by activating and deactivating the vacuum supply.
3. Integrate the signal in the machine control unit so that the workpiece can only be machined once the relevant signal has been received from the vacuum unit and so that the current machining process is interrupted when the signal is no longer transmitted.

#### 5.1.4 Checking the operating vacuum

The vacuum unit generates a vacuum as described below:

1. Close both the discharge valve (1) as well as the manual lever valve (4) for the vacuum connection.
2. Switch the vacuum unit on via the mains switch (12). After powering the VAGG, an acoustic warning signal will sound.
3. Monitor the establishment of the operating vacuum via the manometer (3).  
An acoustic warning tone must be heard until the operating vacuum of -600 mbar is reached.
4. The VAGG operates continuously and it is a maximum, constant vacuum of approx. -930 mbar builds.



The vacuum reached must fall by no more than 100 mbar in the next 20 minutes.

#### 5.1.5 Acoustic warning device and output for machine release

Check the function of the acoustic warning device and the machine release as follows:

1. Close the discharge valve (1) and the manual lever valve (4) for the suction connection.
2. Switch on the vacuum unit at the mains switch (12). After powering the VAGG, an acoustic warning signal will sound.
3. Monitor the establishment of the operating vacuum via the integrated manometer (3).
4. An acoustic warning tone must sound until the operating vacuum of -600 mbar has been reached and the output for the machine release (no electrical signal "0") is interrupted.
5. The warning tone cuts out at -600 mbar and the output for the machine release is signalled (electrical signal "1").
  - ➔ The vacuum unit remains in operation and increases the vacuum until at about -930 mbar reaches a constant vacuum level.
  - ➔ In operation of a clamping device in vacuum valve (4) is open, the vacuum normally drops.
  - ➔ The warning tone is emitted once again and the machine release is interrupted if the operating vacuum falls to -600 mbar or below.

### 5.1.6 Fill level monitor for the liquid separator

Check the function of the fill level monitor for the liquid separator as follows:

1. Close the discharge valve (1) as well as the manual lever valve (4) for the suction connection.
2. Switch on the vacuum unit at the mains switch (12).
3. After reaching the operating vacuum, connect the vacuum hose included in the delivery to the vacuum valve (4) and immerse this in a container with coolant.
4. Carefully open the vacuum valve (4) and suck in the coolant.
5. Pay attention to the visual fill level display (6).
6. The measuring rod rises!
7. The acoustic warning tone sounds when the critical fill level is reached and the output for the machine release is opened.



The critical fill level is marked in red on the measuring rod (6).

8. Close the suction valve (4).
9. Switch off the vacuum unit at the mains switch (12).
10. Ventilate the system by opening the suction valve (4) into the atmosphere.



Make sure that the operating vacuum has completely collapsed before opening the discharge valve (1).

11. Open the discharge valve (1) to drain the liquid storage chamber (2).

### 5.1.7 Energy saving function

The vacuum unit is equipped with an energy saving function. This function is activated by the actuation of the pressure switch (10) and controlled by the integrated vacuum sensor.

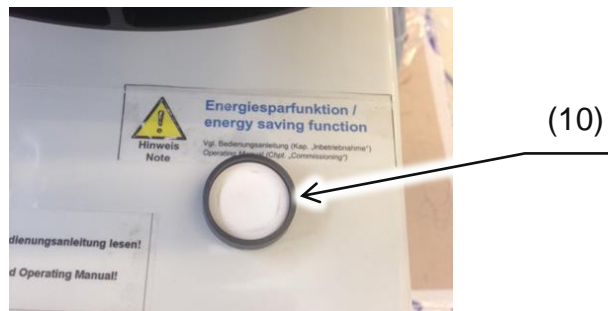

The vacuum pump (8) is switched off when it reaches -800 mbar vacuum (energy saving mode). If the vacuum by leaks in the vacuum system drops below a vacuum of -700 mbar, the vacuum pump (8) is switched on automatically.

**ATTENTION****Starting frequency of VAGG greater than 10 starts / hour**

Destruction of the vacuum pump (8)

- ▶ Operate VAGG in continuous operation

The operation of VAGG in the energy saving mode is allowed at a start frequency  $\leq 10$  starts / hour. At a higher starting frequency the VAGG shall be operated in continuous operation.

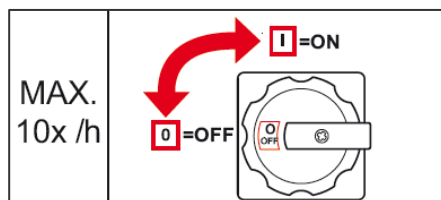

## 6 Operation

The following activities must be performed before starting the vacuum unit:

1. Check and ensure that all safety installations have been attached and are functioning.
2. Check the vacuum unit for visible damage and immediately remove identified defects or report these to the supervisor.
3. The vacuum unit and the machine may only be operated in a flawless condition.
4. Check and ensure that only authorised individuals are located in the machine's or the system's area of operation and that no other individuals are placed at risk by switching on the machine.

**CAUTION**

**The exhaust air of the vacuum pump contains small residual amounts of oil and may contain further gaseous process substances.**

Health hazards

- ▶ Ensure adequate ventilation when the exhaust air is directed into a room where people are located.

A possibly perceptible odor of the exhaust air is not caused by drop-shaped residues of oil, but either by gaseous process substances or by volatile and therefore gaseous constituents of the oil (in particular by additives).

An operating vacuum of at least -600 mbar, which is monitored by a vacuum switch and is visually displayed on the manometer (3), must be reached to machine workpieces on the CNC machining centre.

### 6.1 Connecting to a clamping device

The connection between the vacuum unit and a clamping device is described below:

1. Connect the vacuum hose ( $\varnothing 12$  mm) included in the delivery to the suction valve (4) in order to supply an operating vacuum for a vacuum clamping device.  
The other end is connected to the vacuum clamping device.

2. All valves (1) and (4) must be closed. The electrical supply as well as the integration of the safety installations in the machine control unit must be ensured.
3. Switch the vacuum unit on via the mains switch (12).
4. The suction valve (4) can be opened (vacuum ON) once the operating vacuum has reached a constant vacuum > -600 mbar (see manometer (3)).

The vacuum is now provided for the vacuum clamping device and monitored via the vacuum unit's safety installations. Liquids that are sucked in are separated and collected in the storage chamber (2).

A workpiece positioned on the vacuum clamping device is retained/clamped by the vacuum generated.

## 6.2 Emptying the liquid storage chamber

The liquid storage chamber (2) must be regularly monitored with regard to the fill level of the separated liquid. It must be sufficiently empty at the start of machining.

If the storage chamber (2) reaches the critical fill level it must immediately be emptied as described below:

1. Switch off the vacuum unit and ventilate the system by opening the suction valve (4).
  - ➔ This equalises the vacuum in the storage chamber (2) and atmospheric pressure is established across the entire system.
2. Now place a suitable container next to or below the drainage valve (1).
3. Drain the liquid into the container by carefully opening the drainage valve (1).



A small piece of vacuum hose with an internal diameter of  $\varnothing = 12$  mm inserted in the drainage valve (1) facilitates this task.

### ATTENTION

**Opening the drainage valve (1) while a vacuum exists in the storage chamber (2)**

Separated liquid is sucked into the vacuum pump within seconds and damages the vacuum pump (8)!

- ▶ Make sure that the mains switch (12) is switched to OFF
- ▶ and the manual lever valve (4) is open before draining.



### ATTENTION

**Ignoring the acoustic liquid warning**

Separated liquid is sucked into the vacuum pump (8) and damages the vacuum pump (8)!

- ▶ Immediately stop work when the acoustic liquid warning is triggered.
- ▶ Empty the liquid storage chamber (2) as described above (Chap. 6.2).

## 6.3 Description of the functions

 <b>WARNING</b>	
	<p><b>Machining under the critical vacuum level of -600 mbar</b></p> <p>Risk of injury due to loss of the workpiece</p> <p>► Immediately stop machining if the critical vacuum level is reached.</p>

The vacuum unit defaults operated continuously. That after switching the vacuum pump generates a vacuum up to about -930 mbar.

After the vacuum connection (4) open the vacuum as a function of the tightness (The conditions such as the workpiece material, the condition of the seals, etc.) fall of the vacuum system somewhat.

### 6.3.1 Vacuum monitoring

The generated operating vacuum is monitored by an integrated vacuum sensor.

The acoustic warning tone sounds if the vacuum falls below the critical level of -600 mbar (position A in the flow diagram) and the output for the machine release is interrupted.

#### Vacuum generation and vacuum monitoring flow diagram

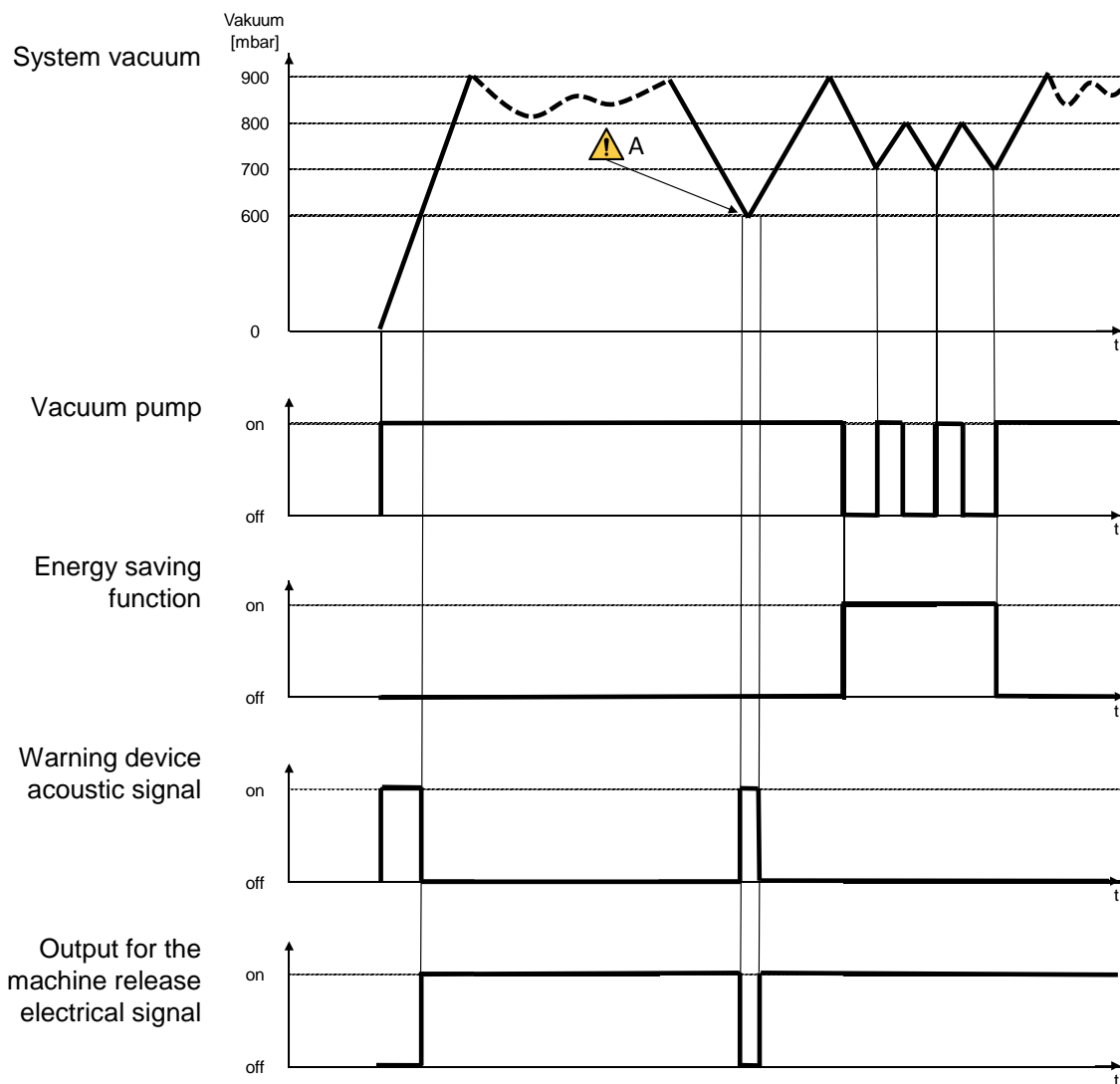

By actuating the pressure switch (10) the energy saving function is started.

Thereby, the vacuum unit is switched off after reaching a vacuum level of -800 mbar automatically to save energy (integrated energy saving function).

For leak-induced decrease in the vacuum below -700 mbar, the vacuum pump (8) will automatically restart.



If the vacuum level drops below the value of -600 mbar, an acoustic alarm is activated and the electric signal of the machine release is interrupted.

### 6.3.2 Fill level monitor for the liquid separator

Liquid contained in the media that is sucked in is collected in the liquid separator (2). The liquid level can be identified by the visual fill level display (6). The fill level sensor triggers an acoustic warning device on reaching the critical fill level, V1, (see position B in the flow diagram on the following page) and the output for the machine release is interrupted.

The machine now has to be switched off and the vacuum chamber (2) must be drained via the drainage valve (1) (cf. Chap. "Emptying the liquid storage chamber").

If the fill level continues to rise (C), a safety valve prevents the vacuum pump (8) from being damaged and blocks the vacuum circuit.

 <b>WARNING</b>	
	<p><b>The liquid fill level (C) rises above the critical level</b></p> <p>Risk of injury due to loss of the workpiece, the vacuum collapses suddenly =&gt; loss of retention force</p> <p>▶ The machine must be turned off and machining activities must be stopped!</p>



Fill level monitoring flow diagram

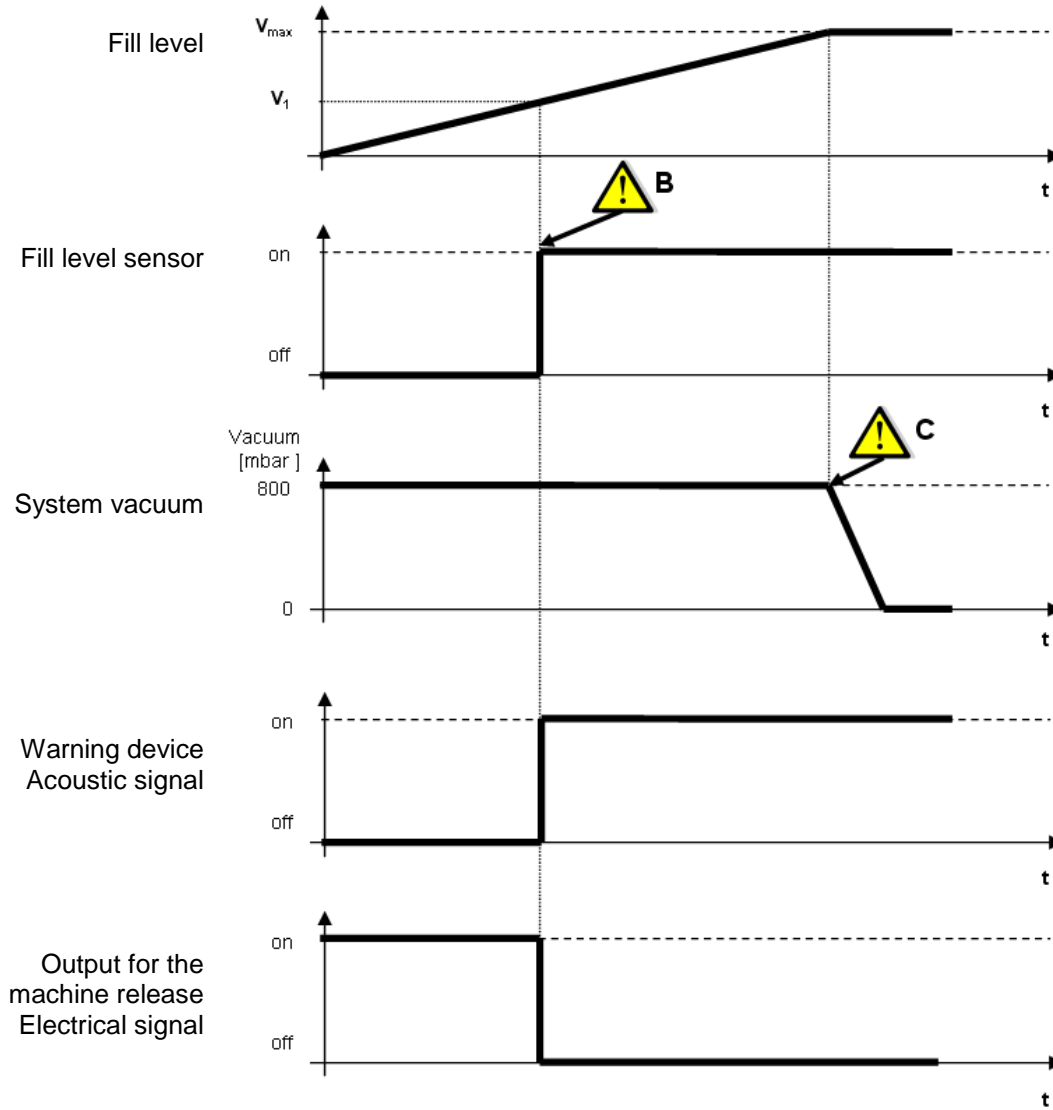

# 7 Troubleshooting

Troubleshooting can require basic mechanical and pneumatic knowledge as well as knowledge of the related technical terms. A corresponding group of persons must therefore be included.

Work on the electronics may only be performed by electricians.

	Possible cause	Remedy
Vacuum unit not working	<ul style="list-style-type: none"> <li>- Electrical connection is incorrect or defective</li> <li>- Power supply interrupted</li> <li>- Only two-phase voltage</li> <li>- Machine circuit breaker triggered</li> </ul>	<ul style="list-style-type: none"> <li>- Check connection and correct if necessary</li> <li>- Check the power cord</li> <li>- Check the fuse and connection</li> <li>- Check whether motor is overloaded or defective. Allow motor to cool. Correct the current motor protection circuit breaker, if necessary and switch on the motor protection circuit breaker.</li> </ul>
Pump is running but a vacuum of -600 mbar is not reached	<ul style="list-style-type: none"> <li>- Motor direction of rotation is incorrect</li> <li>- Excessive leakage in the system</li> <li>- Discharge valve (1) is open</li> </ul>	<ul style="list-style-type: none"> <li>- Reverse the polarity of the connection line</li> <li>- Inspect the vacuum unit and clamping system for leaks!</li> <li>- Close the discharge valve (1)</li> </ul>
No suction despite vacuum	<ul style="list-style-type: none"> <li>- Contamination of the lines or other reduction of the cross-section by dirt</li> <li>- Vacuum openings on the clamping system are soiled</li> <li>- Vacuum hose kinked</li> </ul>	<ul style="list-style-type: none"> <li>- Lines clean</li> <li>- Clean the vacuum openings</li> <li>- Remove kinks from the vacuum hose</li> </ul>
No acoustic warning tone	<ul style="list-style-type: none"> <li>- Vacuum sensor does not respond</li> <li>- Fill level sensor does not respond</li> <li>- Float does not move despite a rising fill level</li> </ul>	<ul style="list-style-type: none"> <li>- Contact your Schmalz contact partner.</li> <li>- Contact your Schmalz contact partner.</li> <li>- Contact your Schmalz contact partner.</li> </ul>
Liquid in the pump oil	<ul style="list-style-type: none"> <li>- Water or droplet separator (7) full</li> <li>- Liquids entering the vacuum pump (8) were not separated</li> <li>- Gas ballast valves on the vacuum pump (8) defective</li> </ul>	<ul style="list-style-type: none"> <li>- Empty and clean the water droplet separator (7)</li> <li>- Clean the oil (see the operating instructions for the vacuum pump (8) TDS 30.30.01.00402)</li> <li>- Replace the gas ballast valve</li> </ul>

# 8 Maintenance



## 8.1 General safety information





Read Chapter 1.6 (Requirements and Information relating to the Installation, maintenance and operating personnel) before starting any maintenance work.

The vacuum unit may only be maintained by qualified experts, mechanics and electricians. All activities associated with the product require fundamental mechanical and pneumatic knowledge as well as knowledge of the related technical terms.

Work on the electronics may generally only be performed by electricians.

! <b>WARNING</b>	
 	<p><b>Risk of accident when maintenance is performed on the system by unqualified personnel</b></p> <p>Consequences include serious personal injury and property damage</p> <ul style="list-style-type: none"> <li>▶ Only qualified personnel that have read and understood the operating instructions may perform maintenance work on the system.</li> </ul>

! <b>WARNING</b>	
 	<p><b>Damage caused by running vacuum generator</b></p> <p>Personal injury</p> <ul style="list-style-type: none"> <li>▶ Switch off the vacuum generator (ejector, fan, pump) when performing cleaning, maintenance and repair work.</li> </ul>

! <b>CAUTION</b>	
	<p><b>Risk of burns from coming into contact with a vacuum pump (8) in continuous operation</b></p> <p>Burns to the skin</p> <ul style="list-style-type: none"> <li>▶ Keep a safe distance away from the vacuum pump (8) and do not touch hot surfaces.</li> <li>▶ Only perform maintenance work after allowing for a 1h cooling period.</li> </ul>

Check the safety installations after carrying out repairs or maintenance activities.

## 8.2 Pump oil maintenance

ATTENTION	
	<p><b>No or incorrect pump oil maintenance</b></p> <p>Destruction of the vacuum pump if the lubricating effect is lost</p> <ul style="list-style-type: none"> <li>▶ Pay attention to the maintenance instructions</li> </ul>

### 8.2.1 Separate pump oil from condensed liquids

The oil must be serviced at regular intervals in order to separate the oil in the vacuum pump (8) from condensed liquids.

Using the gas ballast valve to the accumulation of condensates from the process gas is counteracted in the vacuum pump (8). Existing condensates can be separated again from the oil and transported from the pump:

1. Check that the storage chamber (2) is empty and no longer contains any liquids.
2. Disconnect the vacuum unit from the vacuum circuit by closing the manual valve (4).
3. Make sure that the discharge valve (1) is closed.
4. Turn the mains switch (12) to "ON" and operate in continuous operation.
5. The vacuum unit now generates a vacuum. Keep the vacuum unit switched on for about 20 minutes with constant pumping.

The maintenance takes 20 minutes.

This process must be repeated at regular intervals:

- ➔ Daily, based on 1-shift operation (8h)
- ➔ After the penetration of liquid (check the oil inspection glass (5))



### 8.2.2 Oil quantity and oil change

The maintenance intervals are strongly dependent on the individual operating conditions. The values below are starting values, which should be optionally shortened. The operation under difficult conditions such as high dust levels around or impurities or product entries pumped gas can make a reduction of maintenance intervals required.

Check the level and the color of the oil daily when the VAGG is switched off: The oil level must not fall below the middle of the oil inspection glass (5).

To ensure the pump function, it is necessary to change the oil and the oil filter according to the following time intervals:

- First oil change after 100 hours of operation,
- and then all 500 to 1000 hours of operation,
- at least every six months,
- or if excessive water is absorbed.

 <b>WARNING</b>	
	<p><b>Used oil is released into the environment</b></p> <p>Risk to health and damage to the environment</p> <p>▶ Correct disposal of the used oil in line with the official local regulations.</p>

In addition, please follow the maintenance information in the operating instructions for the relevant vacuum pump (8):

- Operating instructions TDS 30.30.01.00402 must be followed for the VAGG 18 with vacuum pump size 18.

## 9 Warranty, Spare and Wear Parts

### 9.1 Warranty

We provide a warranty in line with our General Terms and Conditions of Sale and Delivery for this system. The same applies for spare parts, if this relates to original parts delivered by us.

We assume no liability for damage caused by the use of non-original spare parts and accessories.

The exclusive use of original wear and spare parts is required in order to guarantee the flawless functioning of the vacuum unit and to maintain the warranty.

All wear parts are not included in the warranty.

<b>ATTENTION</b>	
	<p><b>Use of non-genuine spare and wear parts</b> May result in malfunctions or property damage.</p> <p>► Only use genuine parts provided by J. Schmalz as otherwise the warranty expires.</p>

### 9.2 Spare and wear parts

The key spare and wear parts are indicated in the following list.

Type	Designation	Article no.	Legend
VSL 21-12 PVC-G	Hose for vacuum and compressed air systems	10.07.09.00006	E/Z
VAM 67 V H-SE	Vacuum manometer	10.07.02.00016	E
EVE-OG 18 AC3	VAGG 18 vacuum pump	10.03.02.00070	E
ZUB BEL	Gas ballast valve	22.09.03.00031	E
OEL-EVE-OG-1	Spare oil for vacuum pumps 1.00 L	27.02.01.00055	V
WAS-ABS G3/4-IG	Droplet separator filter	10.07.01.00303	E

Legend: Spare part = E      Wear part = V      Accessory = Z

## 10 Accompanying documents

### 10.1 Vacuum pump operating instructions

Pay attention to the operating and maintenance instructions, BA 30.30.01.00402.

### 10.2 Declaration of Conformity

The Declaration of Conformity is provided on the following page.

DE EU-Konformitätserklärung  
 EN EC- Declaration of Conformity  
 FR CE-Déclaration de conformité  
 ES Certificado de conformidad CE  
 IT Dichiarazione di conformità CE  
 NL CE Conformiteitsverklaring



Hersteller / Manufacturer / Fabricant / Fabricante / Produttore / Fabrikant  
 J. Schmalz GmbH, Aacher-Str. 29, D - 72293 Glatten

Produktbezeichnung / Product name / Designation du produit /  
 Denominación del producto / Denominazione del prodotto /  
 Beschrijving van de machine



Vakuuaggregaat der Serie/ Vacuum unit, Series /  
 Unité de vide de la série / Unità' vuoto /  
 Unidad de vacío serie / Vacuum unit Serie

Erfüllte einschlägige EG-Richtlinien / Applicable EC directives met / Directives CE applicables respectées / Directivas vigentes de la CE cumplidas /  
 Direttive CE applicate ed osservate / Nagekomen betreffende EG-richtlijnen

- 2006/42/EG Maschinenrichtlinie / Machinery Directive / Directive sur les machines / Directiva para máquinas / Direttiva macchine / Machine-richtlijn
- 2014/30/EU Elektromagnetische Verträglichkeit / Electromagnetic Compatibility / Compatibilité électromagnétique / Compatibilidad electromagnética / Compatibilità elettromagnetica / Elektromagnetische compatibiliteit

Angewendete harmonisierte Normen / Harmonised standards applied / Normes d'harmonisation appliquées / Normas armonizadas aplicadas / Norme armonizzate adottate / Toegepaste geharmoniseerde normen

- EN ISO 12100 Sicherheit von Maschinen - Grundbegriffe, allgemeine Gestaltungsgrundsätze - Risikobeurteilung / Safety of Machinery - Basic concepts, general principles for design - Risk assessment / Sécurité des machines - Notions fondamentales, principes généraux de conception - Appréciation du risque / Seguridad de máquinas - Conceptos básicos, principios generales de diseño - Estimación del riesgo / Sicurezza delle macchine - concetti fondamentali, principi generali della progettazione - Valutazione dei rischi / Veiligheid van machines - basisbegrippen, algemene eisen voor het ontwerp en de constructie - Risicobeoordeling
- EN ISO 13849-1 Sicherheit von Maschinen - Sicherheitsbezogene Teile von Steuerungen / Safety of machinery - Safety-related parts of control systems / Sécurité des machines - Parties des systèmes de commande relatives à la sécurité / Seguridad de máquinas - Componentes seguros en sistemas de control / Sicurezza delle macchine - Parti/Componenti di sistemi di comando relativi alla sicurezza / Veiligheid van machines - Onderdelen van besturingssystemen met een veiligheidsfunctie
- EN 60204-1 Sicherheit von Maschinen - Elektrische Ausrüstung von Maschinen / Safety of Machinery - Electrical equipment of machines / Sécurité des machines - Équipement électrique des machines / Seguridad de máquinas - Equipamiento eléctrico de máquinas / Sicurezza delle macchine - Equipaggiamento elettrico delle macchine / Veiligheid van machines - elektrische uitrusting van machines
- EN ISO 13857 Sicherheit von Maschinen - Sicherheitsabstände gegen das Erreichen von Gefährdungsbereichen mit den oberen und unteren Gliedmaßen / Safety of Machinery - Safety distances to prevent hazard zones being reached by upper and lower limbs / Sécurité des machines - Distances de sécurité empêchant les membres supérieurs et inférieurs d'atteindre les zones dangereuses / Seguridad de máquinas: Distancias de seguridad contra el contacto de los miembros superiores e inferiores con zonas de peligro / Sicurezza delle macchine - Distanze di sicurezza per prevenire che le parti superiori ed inferiori raggiungano le aree di pericolo / Veiligheid van machines - veiligheidsafstanden ter voorkoming van het bereiken van gevaarlijke zones met de bovenste en onderste ledematen
- EN 61000-6-4 Elektromagnetische Verträglichkeit - Störaussendung / Electromagnetic Compatibility - Emission / Compatibilité électromagnétique - Norme sur l'émission / Compatibilidad electromagnética - Emisión de interferencias / Compatibilità elettromagnetica - Norma generica sull'emissione / Elektromagnetische compatibiliteit - emissie
- EN 61000-6-3 Elektromagnetische Verträglichkeit - Störaussendung / Electromagnetic Compatibility - Emission / Compatibilité électromagnétique - Norme sur l'émission / Compatibilidad electromagnética - Emisión de interferencias / Compatibilità elettromagnetica - Norma generica sull'emissione / Elektromagnetische compatibiliteit - emissie
- EN 61000-6-2 Elektromagnetische Verträglichkeit - Störfestigkeit / Electromagnetic Compatibility - Immunity / Compatibilité électromagnétique - Immunité / Compatibilidad electromagnética - Resistencia a interferencias / Compatibilità elettromagnetica - Immunità / Elektromagnetische compatibiliteit - immunität
- EN 1012-1 Kompressoren und Vakuumpumpen - Sicherheitsanforderungen / Compressors and Vacuum Pumps - Safety requirements / Compresseurs et pompes à vide - Prescriptions de sécurité / Compresores y bombas de vacío - Requisitos de seguridad / Compressori e pompe per vuoto - requisiti di sicurezza / Compressoren en vacuümpompen - veiligheidsvoorschriften
- EN ISO 2151 Akustik- Kompressoren und Vakuumpumpen, Bestimmung der Geräuschemission / Acoustics - Noise test code for compressors and vacuum pumps / Acoustique - Code d'essai acoustique pour les compresseurs et les pompes à vide / Acústica - Compresores y bombas de vacío, medición del ruido / Acustica di compressori e pompe per vuoto, determinazione dell'emissione di rumori / Akoestiek - Compressoren en vacuümpompen - Bepaling van geluidsemissie



Angewendete nationale Regelwerke / National regulations applied / Réglementations nationales appliquées / Reglamentos nacionales aplicadas /  
 Norme nazionali applicate / Toegepaste nationale regelgeving

BGI 5003 Maschinen der Zerspanung

Dokumentationsverantwortlicher / Person responsible for documentation / Responsable de la documentation / Responsable de documentación /  
 Responsabile della documentazione / Verantwoordelijk voor de documentatie

Glatten, 23.11.2016

/ i.A.

  
 Klaus-Dieter Fanta / J. Schmalz GmbH, Aacher-Str. 29, D - 72293 Glatten

Unterschrift, Angaben zum Unterzeichner / Signature, details of signatory / Signature, indications sur le soussigné / Firma y datos del firmante / Firma,  
 dati concernenti il firmatario / Handtekening, omschrijving van de ondertekenaar

Glatten, 23.11.2016

/ z.v.

  
 Ralf Stockburger  
 Leiter Geschäftsentwicklung und Lieferprozess, Vakuum-Aufspannsysteme /  
 Head of Business Development and Delivery Process, Vacuum Clamping Systems

## Schmalz Services

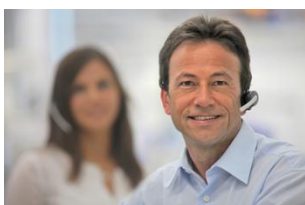

### Contact worldwide

Our sales network with local sales representatives, international branches and trading partners guarantees quick and competent information and advice in over 60 countries worldwide.

 [www.schmalz.com](http://www.schmalz.com)



### Documents online

Download catalogues, operating instructions and CAD data conveniently online and familiarise yourself with our products and services.

[www.schmalz.com](http://www.schmalz.com)

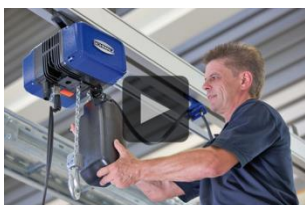

### "How-to...?" videos

The short videos provide a straightforward and clear explanation of the extensive functions of our products. Take a look, it's worth it!

 [www.schmalz.com/en/services](http://www.schmalz.com/en/services)

Additional services, from consulting through to training can be found at

 [www.schmalz.com/en/services](http://www.schmalz.com/en/services)