

SNG-V...HP-HT



Nadelgreifer / NeedleGripper /
Préhenseur à aiguilles / Garra de
agujas / Pinza di presa ad aghi /
Naaldgrijper

J. Schmalz GmbH
Aacher Straße 29
D-72293 Glatten
Tel. +49 (0)7443 2403-0
Fax +49 (0)7443 2403-259
schmalz@schmalz.de
www.schmalz.com

DE Wartungsanleitung
EN Service instructions
FR Instructions de service

ES Instrucciones de mantenimiento
IT Istruzioni per la manutenzione
NL Onderhoudshandleiding

30.30.01.01072/00
06.2016

DE

EN

Diese Wartungsanleitung beschreibt die grundlegenden Arbeitsschritte zur Wartung des Nadelgreifers. Weiterführende und vollständige Funktionsbeschreibungen des Nadelgreifers sind der ausführlichen Betriebsanleitung zu entnehmen.



www.schmalz.com/betriebsanleitung

Es wird ausdrücklich darauf hingewiesen, dass diese Wartungsanleitung keinen Anspruch auf Vollständigkeit erhebt.

These service instructions describes the basic operations for maintenance of the needle gripper. Consult the detailed operating instructions for a more in-depth and complete description of the needlegripper's functions.



www.schmalz.com/operating-instructions

We particularly emphasize that these service instructions make no claim to being exhaustive.

Sicherheitshinweise

Security Note

		WARNUNG
		<p>Nicht-Beachtung der Sicherheitshinweise Schaden an Personen / Anlagen / Systemen</p> <p>▶ Vor der Wartung des Nadelgreifers muss diese Anleitung gelesen und verstanden werden.</p>

		WARNING
		<p>Ignoring the safety guidelines Personal injuries / damage to plants / systems</p> <p>▶ Before servicing the needle gripper these instructions must be read and understood.</p>

		WARNUNG
		<p>Ausführende Nadeln Stich-/ Schnitt- und Kratzverletzungen</p> <p>▶ Stichfeste Handschuhe tragen</p> <p>▶ Greifer vor der Wartung von jeglicher Druckluftzufuhr trennen</p>

		WARNING
		<p>Extending needles Injuries caused by pricks, cuts and scratches</p> <p>▶ Wear cut resistant gloves</p> <p>▶ Always disconnect compressed air supply before carrying out any maintenance work</p>

Wartungsschritte

Maintenance steps

1. Im ausgefahrenen Zustand die Befestigungsschraube der Nadelaufnahmen lösen.

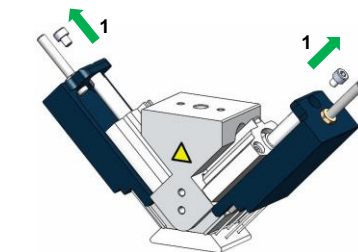

1. When extended, loosen the screws of the needle adapters.

2. Alte Nadelaufnahmen nach hinten herausziehen.

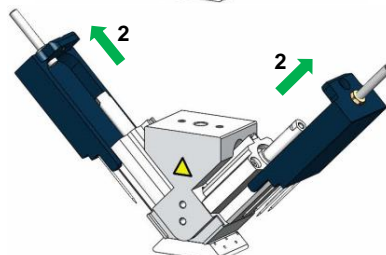

2. Pull out the old needle adapters backwards.

3. Neue Nadelaufnahmen einsetzen.

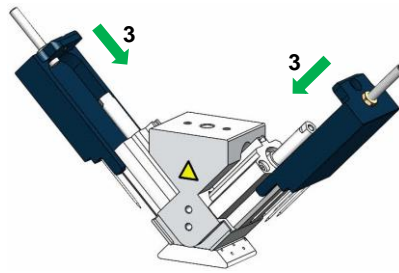

3. Insert a new needle adapter.

4. Nadelaufnahmen mit neuen Befestigungsschrauben fixieren. Einkleben mit mittelfester Schraubensicherung. Beständigkeit bis 180°C muss gewährleistet sein

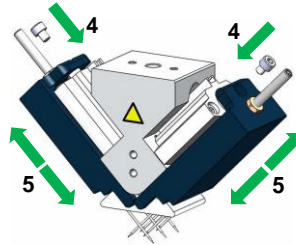

4. Fix the needle adapter with new bolts. Bonding with medium strength threadlocker. Resistance up to 180 ° C must be ensured

5. Gängigkeit der Nadelaufnahmen per Hand überprüfen

5. Check smooth running of the needle adapter by hand

Wiederinbetriebnahme

Erneute Inbetriebnahme des Greifers nach Anschluss der Druckluft.

Recommissioning

Restarting the gripper after connecting the compressed air.

Beachten Sie den Abschnitt „Installation und Betrieb“ der Bedienungsanleitung

See the section "Installation and Operation" of the manual

Ersatz- und Verschleißteile

Für dieses Gerät übernehmen wir eine Gewährleistung gemäß unseren Allgemeinen Verkaufs- und Lieferbedingungen. Das gleiche gilt für Ersatzteile, sofern es sich um von uns gelieferte Originalteile handelt. Für Schäden, die durch die Verwendung von anderen als Originalersatzteilen oder Originalzubehör entstehen, ist jegliche Haftung unsererseits ausgeschlossen.

Spare and wearing parts

We accept liability for this unit pursuant to our General Terms and Conditions of Sale and Delivery. The same applies for spare parts, provided that these are original parts supplied by us. We fully exclude liability for any damages arising from use of spare parts or accessories that are not original parts of accessories.

Verschleißteilesatz	Lieferumfang
10.01.29.00550	2 Nadelaufnahmen inkl. Nadeln, 2 Befestigungsschrauben, 2 Muttern 2 Zylinderschrauben

Wearing part set	Scope of delivery
10.01.29.00521	2 Needle adapters incl. needles, 2 Screws, 2 Nuts 2 Machine screws

Technische Änderungen, Druckfehler und Irrtümer vorbehalten!

The right to make technical changes is reserved. No responsibility is taken for printing errors or other types of errors.

FR

Ce manuel de service décrit les opérations de base pour l'entretien de la pince de l'aiguille. Pour tout complément d'information et la description complète du fonctionnement de préhenseur, veuillez consulter la version complète des instructions de service.

www.schmalz.com/manuels-de-utilisation

Nous attirons votre attention sur le fait que cette Instructions de service n'est pas exhaustive.



ES

Este manual de servicio se describen las operaciones básicas para el mantenimiento de la pinza de aguja. Las descripciones completas de las funciones del garra de agujas se deben consultar en las instrucciones de servicio completas.



www.schmalz.com/manuales-de-instrucciones





Advertimos explícitamente que estas Instrucciones de mantenimiento no pretenden ser completas.





Remarque sur la sécurité

⚠ AVERTISSEMENT	
 	<p>Non-respect des remarques de sécurité</p> <p>Dommages aux personnes / installations / systèmes</p> <p>▶ Avant de réparer la pince d'aiguille ces instructions doivent être lues et comprises.</p>

Indicaciones de seguridad

⚠ ADVERTENCIA	
 	<p>No observación de las indicaciones de seguridad</p> <p>Daños personales / en la instalación / en los sistemas</p> <p>▶ Antes de reparar la pinza aguja estas instrucciones deben ser leídas y entendidas.</p>

⚠ AVERTISSEMENT	
 	<p>Sortie d'aiguilles</p> <p>Blessure par piqûre, coupure ou égratignure</p> <p>▶ Port de gants anti-piqûre</p> <p>▶ Avant de commencer l'entretien du préhenseur, déconnectez l'alimentation en l'air comprimé !</p>
 	

⚠ ADVERTENCIA	
 	<p>Agujas saliendo</p> <p>Lesiones por pinchazos, cortes o arañazos</p> <p>▶ Llevar guantes a prueba de pinchazos</p> <p>▶ Antes de proceder a los trabajos de mantenimiento, desconecte completamente el suministro de aire comprimido a la pinza.</p>
 	

Étapes d'entretien

1. Une fois étendu, desserrez les vis de l'adaptateur d'aiguille.

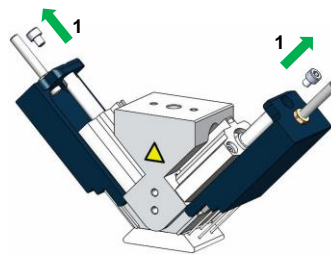

2. Retirez l'ancien adaptateurs d'aiguilles arrière.

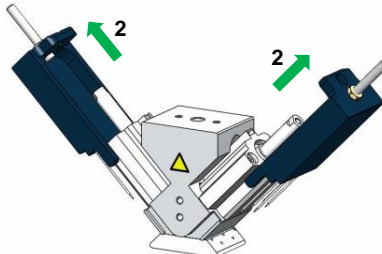

3. Insérez une nouvelle carte de l'aiguille.

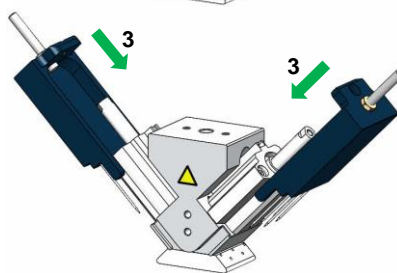

4. Fixez l'adaptateur d'aiguille avec de nouveaux boulons. Collage avec frein filet de force moyenne Résistance jusqu'à 180 ° C doit être assurée

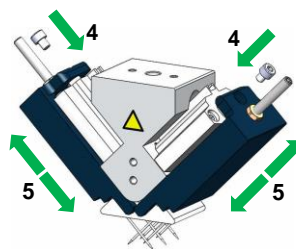

5. Vérifiez le bon fonctionnement de l'adaptateur d'aiguille à la main

Pasos de mantenimiento

1. Cuando está extendido, afloje los tornillos del adaptador de aguja.

2. Saque los viejos adaptadores de aguja hacia atrás.

3. Inserte un nuevo adaptador de aguja.

4. Fije el adaptador de aguja con pernos nuevos. Vinculación con roscas de resistencia media. Resistencia hasta 180 ° C debe garantizarse

5. Compruebe el buen funcionamiento del adaptador de la aguja con la mano.

Recommissioning

Redémarrage de la pince après le raccordement du comprimé.



Voir la section "Installation et fonctionnement" du manuel

Nueva puesta en

Reinicio de la pinza después de conectar el comprimido.



Vea la sección "Instalación y funcionamiento" del manual

Pièces de rechange et d'usure

Nous assurons la garantie de cet appareil conformément à nos conditions générales de vente et de livraison. Ceci s'applique également aux pièces de rechange dans la mesure où il s'agit de pièces d'origine livrées par nous. Nous déclinons toute responsabilité pour des dommages résultant de l'utilisation de pièces de rechange ou d'accessoires non d'origine.

Kit de pièces d'usure	Matériel livré
10.01.29.00550	2 Carte de l'aiguille incl. l'aiguilles, 2 Vis, 2 Écrous, 2 Vis à métaux

Piezas de repuesto y piezas sometidas al desgaste

Por este aparato concedemos una garantía conforme a nuestras condiciones generales de venta y entrega. Lo mismo tiene validez para piezas de repuesto, siempre que sean piezas de repuesto originales suministradas por nosotros. Queda excluido cualquier tipo de responsabilidad de nuestra parte por los daños surgidos por la utilización de piezas de repuesto o accesorios no originales.

Juego de piezas de desgaste	Volumen de suministro
10.01.29.00521	2 Adaptador de aguja incl. agujas, 2 Tornillos, 2 Tuercas 2 Tornillos de máquina

Sous réserve de modifications techniques, de fautes d'impression ou d'erreurs !

Reservado el derecho a realizar modificaciones por causas técnicas. / No nos responsabilizamos por fallos en la impresión u otros errores.

IT

Queste istruzioni descrivono le operazioni di base per mantenere la needlegripper. Una descrizione più dettagliata e completa del funzionamento del pinze di presa ad aghi è riportata nella versione integrale delle Istruzioni per l'uso.



www.schmalz.com/istruzioni-uso

Si fa notare espressamente che questa guida breve non ha alcun intento di completezza.

NL



Deze montage-instructies beschrijven de basisstappen voor het needlegripper behouden. Verdergaande en volledige beschrijvingen van de werking van de tang van de naald zijn in de uitvoerige bedieningsinstructies te vinden.





www.schmalz.com/gebruikershandleidingen





Wij wijzen er met nadruk op dat er voor wat deze korte handleiding betreft geen aanspraak op volledigheid kan worden gemaakt.





Indicazioni di sicurezza

 AVVERTENZA	
 	<p>Inosservanza delle indicazioni di sicurezza</p> <p>Danni a persone / impianti / sistemi</p> <p>► Prima di riparare la pinza ago queste istruzioni devono essere lette e comprese.</p>

Veiligheidsinstructies

 WAARSCHUWING	
 	<p>Niet-inachtneming van de veiligheidsinstructies</p> <p>Personenschade en schade aan installaties / systemen</p> <p>► Voordat u de naald grijper deze instructies moeten worden gelezen en begrepen.</p>

 AVVERTENZA	
 	<p>Estrazione di aghi</p> <p>Lesioni da puntura, taglio e graffio</p> <p>► Munirsi di guanti da lavoro adeguati</p> <p>► Prima di effettuare la manutenzione, scollegare l'alimentazione dell'aria compressa.</p>
	

 WAARSCHUWING	
 	<p>Uitschuivende naalden</p> <p>Steek-, snij- en krasverwondingen</p> <p>► Snij- en steekbestendige handschoenen dragen</p> <p>► Koppel de grijper vóór het onderhoud van de persluchttoevoer los.</p>
	

Passaggi di manutenzione

1. In tensione, allentare le viti dell'adattatore ago.
2. Estrarre le vecchie schede ago indietro.
3. Inserire un nuovo adattatore ago.
4. Fissare l'adattatore ago con nuovi bulloni. Incollare con filetti di media forza. Resistenza fino a 180 ° C deve essere assicurata
5. Controllare buon funzionamento dell'adattatore dell'ago a mano.

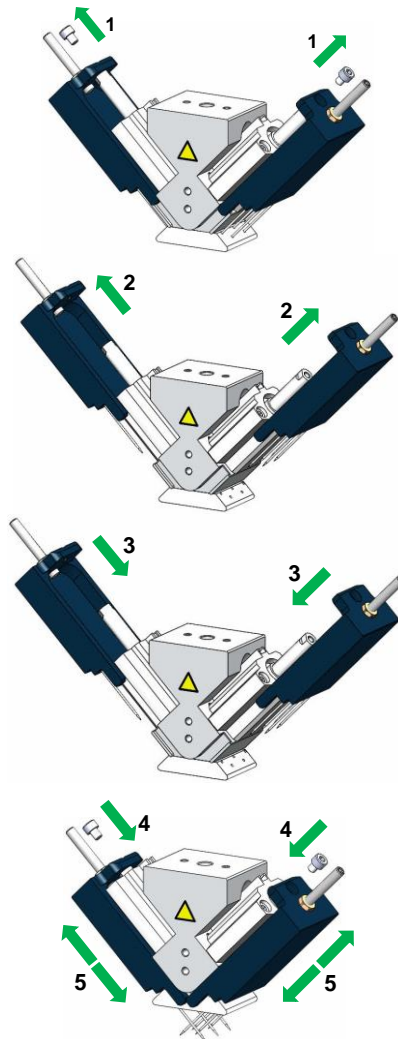

Onderhoud stappen

1. Een uitbreiding van de schroeven van de naald adapter.
2. Trek de oude naald adapters achteruit.
3. Plaats een nieuwe naald adapter.
4. Bevestig de naald adapter met nieuwe bouten. Binding met gemiddelde sterkte. Weerstand tot 180 ° C worden gewaarborgd
5. Controleer goede werking van de naald adapter hand.

Re-commissioning

Riavvio la pinza dopo aver collegato l'aria compressa.



Vedere la sezione "Installazione e funzionamento" del manuale

Le istruzioni per l'uso sono state redatte in tedesco. Custodirle per una successiva consultazione!

Her-ingebruikname

Herstarten van de gripper na de perslucht aansluiten.



Zie het hoofdstuk "Installatie en bediening" van de handleiding

Deze bedieningsinstructies zijn oorspronkelijk in het Duits opgesteld en vertaald naar het Nederlands. Bewaar deze bedieningsinstructies op een veilige plaats als naslagwerk voor op een later tijdstip!

Pezzi di ricambio e parti soggette ad usura

Per il presente apparecchio concediamo una garanzia secondo quanto stabilito nelle condizioni generali di vendita e di consegna. Lo stesso vale per i pezzi di ricambio, purché si tratti di ricambi originali forniti da noi. Non ci assumiamo nessuna responsabilità per eventuali danni causati dall'impiego di ricambi o accessori diversi da quelli originali.

Indossando set parte	Volume di fornitura
10.01.29.00550	2 Adattatori aghi con aghi, 2 Vite, 2 Dados, 2 Vite a testa cilindrica

Con riserva di modifiche tecniche, refusi ed errori!

Reserveonderdelen en slijtdelen

Op dit toestel verlenen wij garantie conform onze algemene verkoop- en leveringsvoorwaarden. Dat geldt tevens voor reserveonderdelen, voor zover deze origineel en door ons geleverd zijn. Voor schade die ontstaat door het gebruik van niet-originele reserveonderdelen of niet-originele accessoires zijn wij niet aansprakelijk.

Dragen van een deel set	Omvang van de levering
10.01.29.00521	2 Naald adapters met naalden, 2 Schroef, 2 Moers, 2 Cylinderschroef

Technische wijzigingen, drukfouten en vergissingen voorbehouden!