

# SCPSi series

Eco - Düsentecnologie

**IO-Link**

SCPSi – 2 - xx – xx – NO – M12-5

SCPSi – 2 - xx – xx – NC – M12-5

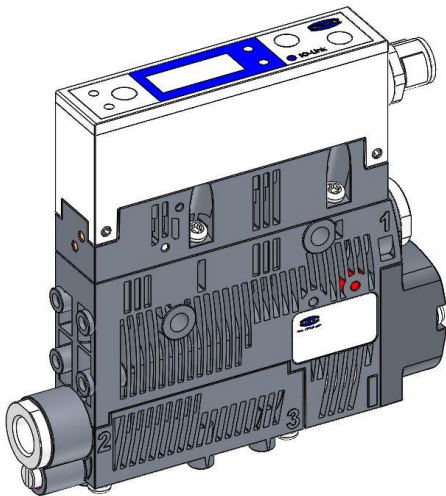

<b>D</b>	<b>Kurzanleitung</b>	<b>1</b>
<b>GB</b>	<b>Brief Operating Instructions</b>	<b>1</b>
<b>F</b>	<b>Notice d'utilisation</b>	<b>1</b>
<b>ES</b>	<b>Instrucciones resumidas</b>	<b>5</b>
<b>IT</b>	<b>Guida breve</b>	<b>5</b>
<b>NL</b>	<b>Korte handleiding</b>	<b>5</b>

Sicherheitshinweise / Security Note / Remarque sur la sécurité			
	<b>D</b>	<b>GB</b>	<b>F</b>
	<p>Diese Kurzanleitung beschreibt die grundlegenden Funktionen des Ejektors und dient erfahrenen Anwendern als Schnelleinstieg. Weiterführende und vollständige Funktionsbeschreibungen des Ejektors sind der ausführlichen Betriebsanleitung zu entnehmen.</p> <p><b>Siehe: <a href="http://www.schmalz.com">www.schmalz.com</a></b></p>	<p>These brief operating instructions describe the basic functions of the ejector. They are intended to provide a quick start for experienced users. Consult the detailed operating instructions for a more in-depth and complete description of the ejector's functions.</p> <p><b>See: <a href="http://www.schmalz.com">www.schmalz.com</a></b></p>	<p>Cette notice décrit les fonctions de base de l'éjecteur et sert de présentation rapide aux utilisateurs expérimentés. Pour tout complément d'information et la description complète du fonctionnement de l'éjecteur, veuillez consulter la version complète des instructions de service.</p> <p><b>Voir: <a href="http://www.schmalz.com">www.schmalz.com</a></b></p>
	<p>Vor Inbetriebnahme des Ejektors sind grundsätzlich die Sicherheitshinweise der ausführlichen Betriebsanleitung zu beachten.</p> <p>Es wird ausdrücklich darauf hingewiesen, dass diese Kurzanleitung keinen Anspruch auf Vollständigkeit erhebt.</p>	<p>You must observe the safety instructions found in the detailed operating instructions before starting to operate the ejector.</p> <p>We particularly emphasize that these brief operating instructions make no claim to being exhaustive.</p>	<p>Veillez impérativement respecter les consignes de sécurité contenues dans les instructions de service détaillées avant de mettre l'éjecteur en service.</p> <p>Nous attirons votre attention sur le fait que cette notice d'utilisation n'est pas exhaustive.</p>
	<p>Der Betrieb des Ejektors ist ausschließlich über Netzgeräte mit Schutzkleinspannung (PELV) gestattet. Es ist für sichere elektrische Trennung der Versorgungsspannung gemäß EN60204 zu sorgen.</p>	<p>The ejector may only be operated via power supply units with protected extra-low voltage (PELV). The system must incorporate safe electrical cut-off of the power supply in compliance with EN60204.</p>	<p>Le fonctionnement de l'éjecteur est autorisé exclusivement via des blocs secteur avec très basse tension de protection (PELV). Garantisiez une séparation électrique efficace de la tension d'alimentation conformément à EN 60204.</p>

## Geräteaufbau / Configuration / Configuration

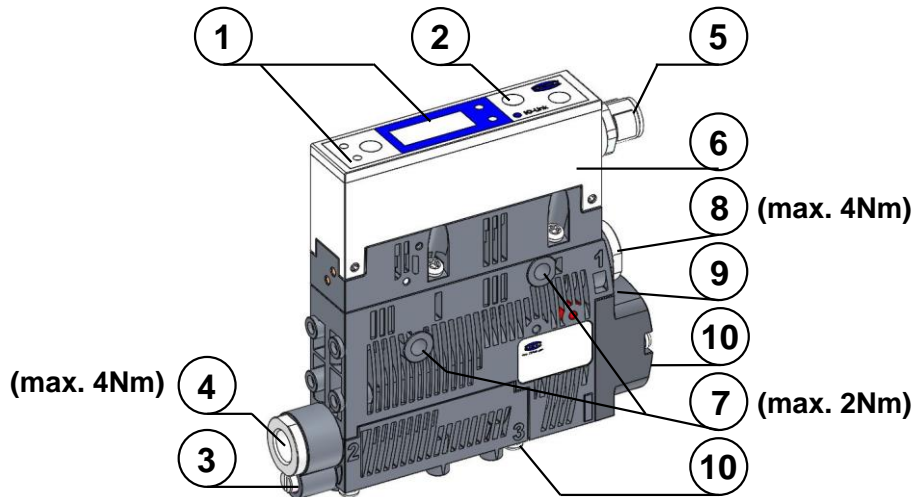

1	Anzeige Prozesszustand	Process state display	Affichage de l'état du processus
2	Bedienelemente	Control elements	Élément de commande
3	Drosselschraube Abblasen	Throttle screw Blow-Off	Throttle vis de purge
4	Vakuumananschluss G1/8"	Vacuum connector G1/8"	Raccord de vide G1/8"
5	Elektrischer Anschluss M12-5	Electrical connection M12-5	Connexion électrique M12-5
6	Steuerung	Control unit	Boîtier de commande
7	Befestigungsbohrungen für M4	Mounting hole for M4	Trou de fixation pour M4
8	Druckluftanschluss G1/8"	Compressed air connection G1/8"	Raccord d'air comprimé G1/8"
9	Schalldämpferdeckel	Cover of the silencer	Couverture du silencieux
10	Abluftausgang	Exhaust outlet	Sortie d'échappement

## Grundeinstellung / Basic Setting / Réglages de base

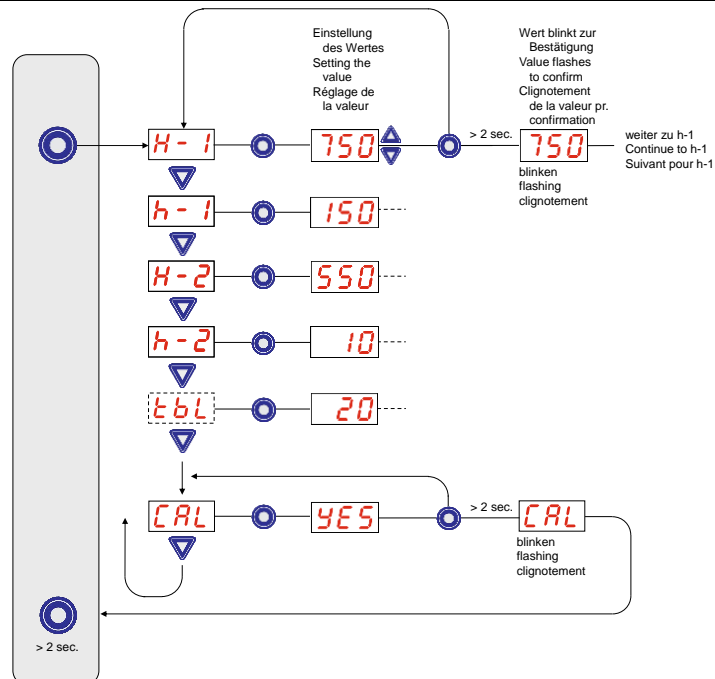

H-1 / h-1	Einstellung der Schaltschwelle der Luftsparfunktion	Setting the switching threshold of the air saving function	Définir le seuil de commutation de la fonction d'économie d'air
H-2 / h-2	Einstellung der Schaltschwelle der Teilekontrolle	Setting the switching threshold of the part control	Définir le seuil de commutation de la contrôle part
tbl	Einstellung der Abblaszeit	Setting the Blow-Off-time	Définir le temp de soufflage
CAL	Nullpunkteinstellung für Vakuumsensor	Zero point setting vacuum-sensor	Réglage du point zéro capteur de vide

## Elektrischer Anschluss / Electrical connection / Branchement électrique

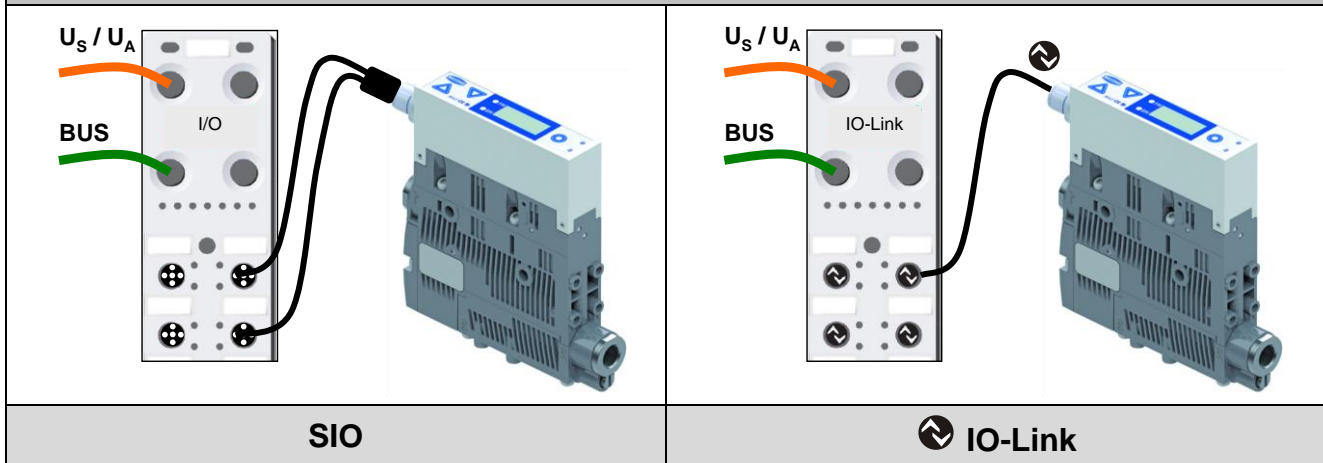

SCPSi – xx – xx – xx – M12-5						
U <sub>S/A</sub> (24V <sub>DC</sub> )	BN	1		1	BN	U <sub>S/A</sub> (24V <sub>DC</sub> )
Saugen / Suction / Aspiration	WH	2		2	WH	-
Gnd <sub>SA</sub>	BU	3		3	BU	Gnd <sub>S/A</sub>
H2	BK	4		4	BK	C/Q (IO Link)
Abblasen / Blow-off / Soufflag	GY	5		5	GY	-

## Betriebsparameter elektrisch / Operating parameters electrically / Paramètres de fonctionnement électriquement

				min	typ	max	
Versorgungsspannung	Supply voltage	Tension d'alimentation	U <sub>S/A</sub>	19,2	24	26,4	V <sub>DC</sub>
Nennstrom (U <sub>S/A</sub> )	Nominal current (U <sub>S/A</sub> )	Courant nominal (U <sub>S/A</sub> )					
			SCPSi – xx – NO	I <sub>S/A</sub>	-	120	- mA
			SCPSi – xx – NC	I <sub>S/A</sub>	-	70	- mA
Ausgangsstrom (PNP)	Output current (PNP)	Courant de sortie (PNP)	I <sub>O</sub>	-	-	150	mA
Ausgangsstrom (NPN)	Output current (NPN)	Courant de sortie (NPN)	I <sub>O</sub>	-	-	100	mA

## Betriebsparameter pneumatisch / Operating parameters pneumatically / Paramètres de fonctionnement pneumatiquement

				p	2	4	6	bar
Betriebsdruck	Operating pressure	Pression de fonction						
Luftverbrauch	Air consumption	Consommation d'air						
			SCPSi 2-07	Q		24		l/min
			SCPSi 2-09	Q		37		l/min
			SCPSi 2-14	Q		87		l/min

IO-Link Kommunikation / Communication / Communication			
SIO-Mode	SIO-Mode	SIO-Mode	Yes
Frame-Typ	Frame-Type	Frame-Typ	2_V
Baudrate	Baud rate	Débit en bauds	38,4 kBd
Minimale Zykluszeit	Minimum cycle time	Temps de cycle minimum	3,3 ms
Prozessdaten input / output	Processdata input / output	Traiter les données input / output	4 byte / 2 byte

IO-Link Prozessdaten / Process Data / Données de process				
	<b>Bit</b>			
<b>PD-In Byte 0</b>	0	H2 (Teilekontrolle)	H2 (Part Control)	H2 (Contrôle part)
	1	H1 (Regelung)	H1 (Control)	H1 (Contrôle)
	5	Systemstatus grün	System status green	L'état du système: vert
	6	Systemstatus gelb	System status yellow	L'état du système: jaune
	7	Systemstatus rot	System status red	L'état du système: rouge
<b>PD-Out Byte 0</b>	0	Saugen EIN/AUS	Suction On / OFF	Aspiration ON / OFF
	1	Abblasen EIN/AUS	Blow-off ON / OFF	Soufflage ON / OFF
	2	Einrichtbetrieb EIN/AUS	Set-Up mode ON / OFF	Mode de configuration ON / OFF
	6	Produktions-Setup-Profil, Bit 0	Production profile setup, Bit 0	Config du profil de product, Bit 0
	7	Produktions-Setup-Profil, Bit 1	Production profile setup, Bit 1	Config du profil de product, Bit 1
		Alle Prozessdaten siehe ausführliche Betriebsanleitung	All Process data see detailed operating instructions	Toutes les données de process voir les instructions d'utilisation

IO-Link Parameter (teilweise) / Parameters (partial) / Paramètre (partielle)				
64	2	Systemvakuum	System vacuum	Vide du système
130	1	Fehler-Code	Error Code	Code d'erreur
146	1	Warnungs-Code	Warning Code	Code d'avertissement
68	1	Luftsparfunktion	Air saving function	Fonction d'économie d'air
78	1	Deaktivierung Dauersaugen	Disable continous sucking	Désactiver continue de sucer
100	2	Schaltpunkt H1	Switchingpoint H1	Point de commutation H1
101	2	Hysterese h1	Hysteresis h1	Hystérésis h1
102	2	Schaltpunkt H2	Switchingpoint H2	Point de commutation H2
103	2	Hysterese h2	Hysteresis h2	Hystérésis h2
106	2	Abblaszeit	Blow-off time	Temps de soufflage
107	2	Zulässige Evakuierungszeit	Permissible evacuation time	Temps d'évacuation permis
108	1	Zulässiger Leckagewert	Permissible leakage value	Valeur de fuite admissible
69	1	Abblasfunktion	Blow-off mode	Fonction de purge
71	1	Funktion OUT2	OUT2 function	OUT2 fonction
73	1	Signaltyp	Signal type	Type de signal
74	1	Vakuumeinheit	Vacuum display unit	Présentoir vide
75	1	Ausschaltverzögerung	Switch-off delay	Délai de mise hors circuit
79	1	Displaydrehung	Display rotation	Rotation d'affichage
76	1	Eco-Modus	Eco-Mode	Eco-Mode
77	2	PIN-Code	PIN-code	PIN-Code
		Alle Parameter siehe ausführliche Betriebsanleitung	All Parameters see detailed operating instructions	Tous les paramètres voir les instructions d'utilisation

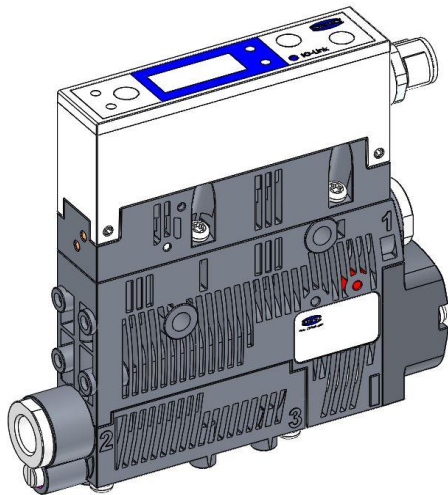

- ES** Instrucciones resumidas
- IT** Guida breve
- NL** Korte handleiding

<b>Indicaciones de seguridad / Indicazioni di sicurezza / Veiligheidsinstructies</b>			
	<b>ES</b>	<b>IT</b>	<b>NL</b>
	<p>Estas instrucciones resumidas describen las funciones básicas del eyector y sirven de acceso rápido para el usuario experimentado. Las descripciones completas de las funciones del eyector se deben consultar en las instrucciones de servicio completas.</p> <p><b>Véase: <a href="http://www.schmalz.com">www.schmalz.com</a></b></p>	<p>Questa guida breve descrive le funzioni principali dell'eiettore ed è prevista per una rapida introduzione per gli utenti esperti. Una descrizione più dettagliata e completa del funzionamento dell'eiettore è riportata nella versione integrale delle Istruzioni per l'uso.</p> <p><b>Vedi: <a href="http://www.schmalz.com">www.schmalz.com</a></b></p>	<p>Deze korte handleiding beschrijft de wezenlijke functies van de ejector en is bedoeld voor ervaren gebruikers teneinde snel aan de slag te kunnen. Verdergaande en volledige beschrijvingen van de werking van de ejector zijn in de uitvoerige bedieningsinstructies te vinden.</p> <p><b>Zie: <a href="http://www.schmalz.com">www.schmalz.com</a></b></p>
	<p>Antes de poner en marcha el eyector, es imprescindible observar las normas de seguridad de las instrucciones de manejo completas.</p> <p>Advertimos explícitamente que estas instrucciones resumidas no pretenden ser completas.</p>	<p>Prima della messa in funzione dell'eiettore, leggere attentamente le indicazioni di sicurezza riportate nella versione integrale delle Istruzioni per l'uso.</p> <p>Si fa notare espressamente che questa guida breve non ha alcun intento di completezza.</p>	<p>Vóór de inbedrijfstelling van de ejector dienen principieel de veiligheidsinstructies zoals die zijn vermeld binnen de uitvoerige bedieningsinstructies in acht te worden genomen.</p> <p>Wij wijzen er met nadruk op dat er voor wat deze korte handleiding betreft geen aanspraak op volledigheid kan worden gemaakt.</p>
	<p>El eyector se debe operar sólo con fuentes de alimentación con baja tensión de protección (PELV). Se debe procurar una desconexión eléctrica segura de la tensión de alimentación según EN60204.</p>	<p>Il funzionamento dell'eiettore è ammesso esclusivamente mediante alimentatori di rete con bassa tensione di protezione (PELV). È necessario garantire la separazione elettrica sicura della tensione di alimentazione, secondo EN 60204.</p>	<p>Het in werking stellen van de ejector is uitsluitend toegestaan met gebruikmaking van voedingsadapters met een veilige, zeer lage spanning (PELV). Er dient voor een veilige elektrische scheiding van de voedingsspanning conform EN60204 te worden gezorgd.</p>

## Estructura del aparato / Struttura dell'apparecchio / Opbouw van de apparatuur

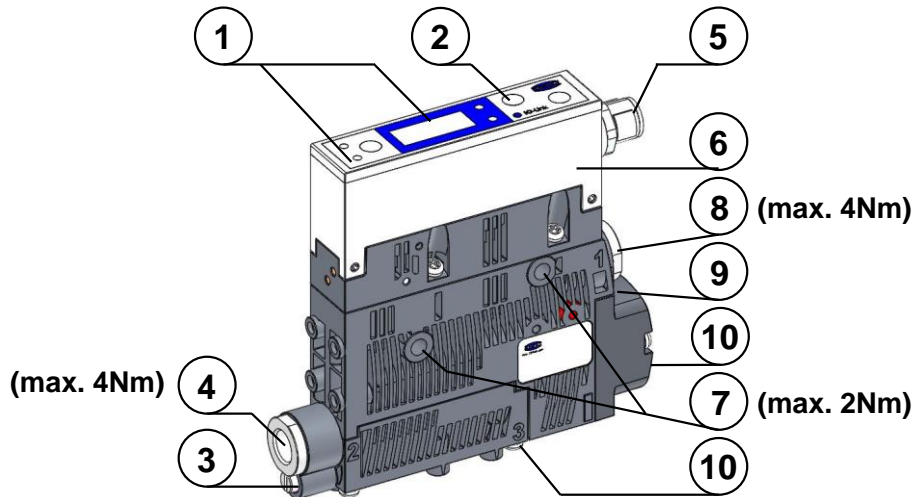

1	Visualización de estado del proceso	Visualizzazione di stato del processo	Geven van proces-state
2	Elemento de manejo	Elemento di comando	Bedieningselement
3	Acelerador tornillo de purga	Acceleratore colpo vite Off	Throttle schroef Blow Off
4	Conexión de vacío G1/8"	Attacco per vuoto G1/8"	Vacuümaansluiting G1/8"
5	Conexión eléctrica M12-5	Collegamento elettrico M12-5	Elektrische aansluiting M12-5
6	Control	Comando	Besturing
7	Orificios de fijación para M4	Fori di fissaggio per M4	Montageboorgaten voor M4
8	Conexión de aire comprimido G1/8"	Attacco aria compressa G1/8"	Persluchtaansluiting G1/8"
9	Cubierta del silenciador	Copertina del silenziatore	Cover van de geluiddemper
10	Salida de escape	Scarico	Uitlaat

## Ajuste (parcial) / Impostazione (parziale) / Instelling (gedeeltelijk)

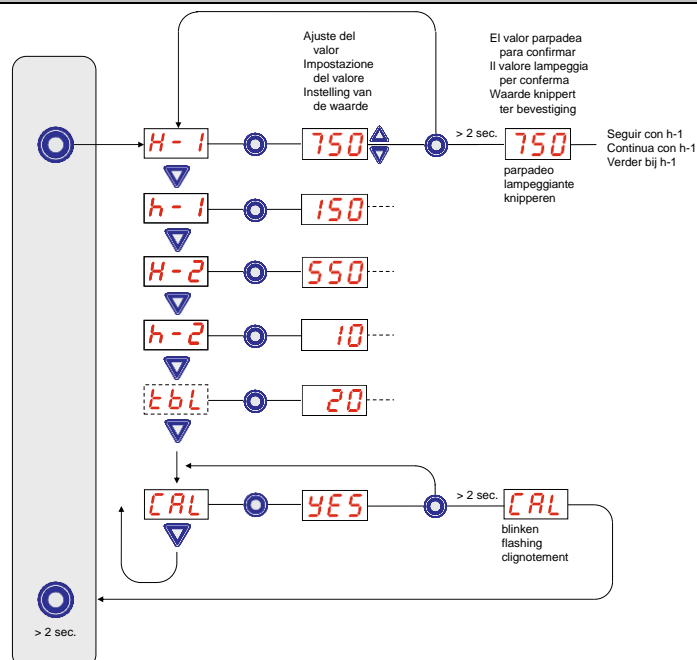

H-1 / h-1	Ajuste del umbral de conmutación de la regulación de ahorro de aire	Impostazione della soglia d'intervento del dispositivo di risparmio dell'aria	Instelling van de schakeldrempel van de luchtsparregeling
H-2 / h-2	Ajuste del umbral de conmutación del control de las piezas	Impostazione della soglia d'intervento del controllo pezzi	Instelling van de schakeldrempel van de onderdelen-controle
tbl	Ajuste del tiempo de soplado	Impostazione del tempo di soffiaggio	Instelling van de afblaastijd
CAL	Ajuste del punto cero para el sensor de vacío	Impostazione origine per sensore di vuoto	Nulpunt-instelling voor vacuüm- sensor

### Conexión eléctrica / Collegamento elettrico / Elektrische aansluiting

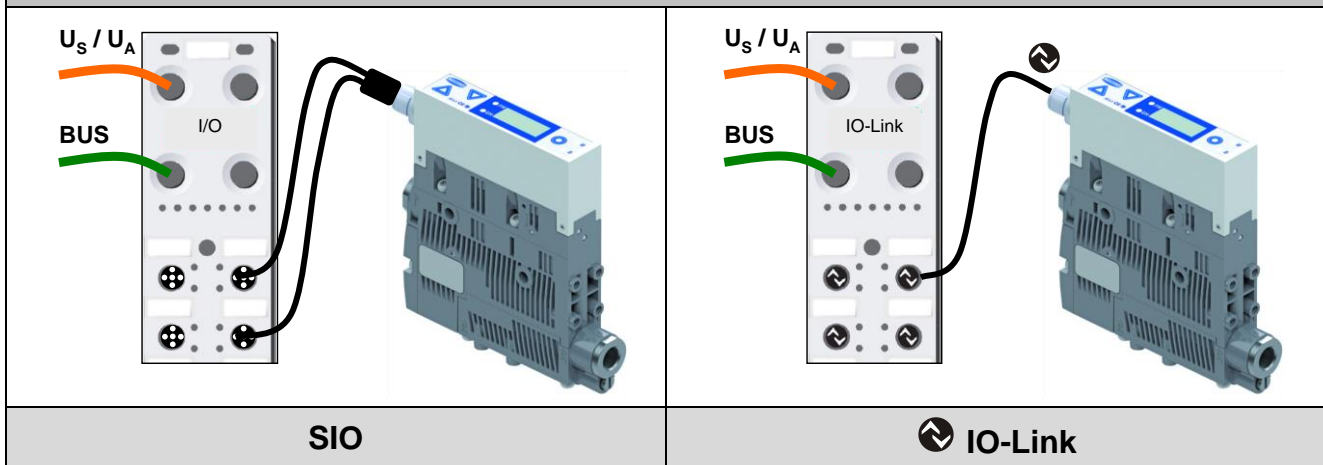

SCPSi – xx – xx – xx – M12-5						
U <sub>S/A</sub> (24V <sub>DC</sub> )	BN	1		1	BN	U <sub>S/A</sub> (24V <sub>DC</sub> )
Aspirar / Aspirazione / Zuigen	WH	2		2	WH	-
Gnd <sub>S/A</sub>	BU	3		3	BU	Gnd <sub>S/A</sub>
H2	BK	4		4	BK	C/Q (IO-Link)
Descargar / Soffiaggio / Afblazen	GY	5		5	GY	-

### Parámetros de operación eléctrica / Parametri di funzionamento elettricamente / Bedrijfsparameters elektrisch

			min	typ	max		
Tensión de alimentación	Tensione di alimentazione	Voedingsspanning	U <sub>S/A</sub>	19,2	24	26,4	V <sub>DC</sub>
Intensidad nominal (U <sub>S/A</sub> )	Corrente nominale (U <sub>S/A</sub> )	Nominale stroom (U <sub>S/A</sub> )					
SCPSi – xx – NO			I <sub>S/A</sub>	-	120	-	mA
SCPSi – xx – NC			I <sub>S/A</sub>	-	70	-	mA
Corriente de salida (PNP)	Corrente di uscita (PNP)	Uitgangsstroom (PNP)	I <sub>o</sub>	-	-	150	mA
Corriente de salida (NPN)	Corrente di uscita (NPN)	Uitgangsstroom (NPN)	I <sub>o</sub>	-	-	100	mA

### Parámetros de funcionamiento neumáticamente / Parametri di funzionamento pneumaticamente / Bedrijfsparameters pneumatisch

			p	2	4	6	bar
Presión de trabajo	Pressione di esercizio	Werkdruk					
Consumo de aire	Consumo d'aria	Luchtverbruik					
SCPSi 2-07			Q		24		25
SCPSi 2-09			Q		37		42
SCPSi 2-14			Q		87		101

IO-Link Comunicación / Comunicazione / Communicatie			
SIO-Mode	SIO-Mode	SIO-Mode	Yes
Frame-Typ	Frame-Type	Frame-Typ	2_V
Tasa de baudios	Baudrate	Baudrate	38,4 kBd
Tiempo mínimo de ciclo	Tempo ciclo minimo	Minimale cyclustijd	3,3 ms
Datos de proceso input / output	Dati di processo input/output	Procesdata input / output	4 byte / 2 byte























IO-Link Datos de proceso / Dati di processo / Procesdata				
<b>I</b>	<b>Bit</b>			
<b>PD-In Byte 0</b>	0	H2 (Control de piezas)	H2 (controllo pezzi)	H2 (Onderdelen-controle)
	1	H1 (Regulación)	H1 (regolazione)	H1 (Regeling)
	5	Estado del sistema verde	Stato del sistema verde	Systeemstatus groen
	6	Estado del sistema amarillo	Stato del sistema giallo	Systeemstatus geel
	7	Estado del sistema rojo	Stato del sistema rosso	Systeemstatus rood
<b>PD-Out Byte 0</b>	0	Aspirar ON/OFF	Aspirazione ON/OFF	Zuigen AAN/UIT
	1	Descargar ON/OFF	Soffiaggio ON/OFF	Afblazen AAN/UIT
	2	Modo de ajuste ON/OFF	Modo di installazione ON/OFF	Instelmodus AAN/UIT
	6	Config d perf de proucc, Bit 0	Prod installaz profilo, Bit 0	Productie profiel setup, Bit 0
	7	Config d perf de proucc, Bit 1	Prod installaz profilo, Bit 1	Productie profiel setup, Bit 1
		Todos los datos de proceso ver instrucciones detalladas	Tutti i dati di processo vedere istruzioni dettagliate	Alle Process data zie gedetailleerde gebruiksaanwijzing

IO-Link Parámetros (parciales) / Parametri (parziali) / Parameters (gedeeltelijk)				
64	2	Sistema de vacío	Sistema di vuoto	Systeem vacuüm
130	1	Código de error	Codice di errore	Foutcode
146	1	Código de advertencia	Codice di avviso	Waarschuwingscode
68	1	Función de ahorro de aire	Funzione di risparmio Air	Air saving functie
78	1	Desactivar la continua succión	Disabilitare continuo succhiare	Uitschakelen continue zuigen
100	2	Punto de conmutación H1	Punto di commutazione H1	Schakelpunt H1
101	2	Histéresis h1	Isteresi h1	Hysteresis h1
102	2	Punto de conmutación H2	Punto di commutazione H2	Schakelpunt H2
103	2	Histéresis h2	Isteresi h2	Hysteresis h2
106	2	Tiempo Blow-off	Tempo di Blow-off	Blow-off tijd
107	2	Tiempo de evacuación per-	Tiempo de evacuación permiti-	Toegestane evacuatietijd
108	1	Valor de fuga admisible	Valore di trafilamento	Toegestane lekwaarde
69	1	Modo de Blow-off	Modalità di Blow-off	Blow-off-stand
71	1	Función OUT2	Funzione OUT2	Functie OUT2
73	1	Tipo de señal	Tipo di segnale	Signaaltype
74	1	Unidad de visualización de	Unità display vuoto	Vacuüm beeldscherm
75	1	Retardo de desconexión	Ritardo di spegnimento	Uitschakelvertraging
79	1	Rotación de la pantalla	Rotazione del display	Rotatie van het beeldscherm
76	1	Eco-Mode	Eco-Mode	Eco-modus
77	2	PIN-Code	PIN-Code	PIN-Code
		Para todos los parámetros, véanse las instrucciones de servicio completas	Per tutti i parametri vedere la versione integrale delle Istruzioni per l'uso	Alle parameters zie uitvoerlijke bedieningsinstructies



## ANZEIGESYMBOLS ÜBERSICHT / OVERVIEW OF DISPLAY SYMBOLS

Symbol	Funktion	Bemerkung
H-1	Schaltpunkt H1 Switching point H1	Ausschaltwert der Luftsparfunktion Switch-off value for the air-saving function
h-1	Hysterese h1 Hysteresis h1	Hysterese der Luftsparfunktion Hysteresis of the air-saving function
H-2	Schaltpunkt H2 Switching point H2	Einschaltwert Signalausgang „Teilekontrolle“ Switch-on value for the “part present control” signal output
h-2	Hysterese h2 Hysteresis h2	Hysterese Signalausgang „Teilekontrolle“ Hysteresis of “part present control” signal output
tbl	Abblaszeit Blow-off time	Einstellung der Abblaszeit für zeitgesteuertes Abblasen Blow-off time setting for time-controlled blow-off
cal	Nullpunkteinstellung Zero-point adjustment	Kalibrierung des Vakuumsensors Calibration of the vacuum sensor
cc1	Gesamtzähler 1 Total counter 1	Zähler für Saugzyklen (Signaleingang „Saugen“) Counter for suction cycles (suction signal input)
cc2	Gesamtzähler 2 Total counter 2	Zähler für Ventilschalzhäufigkeit Counter for valve switching frequency
SoC	Softwareversion Software version	Zeigt die aktuelle Softwareversion an Displays the current software version
Art	Artikelnummer Article number	Zeigt die Artikelnummer des Ejektors an Displays the article number of the ejector
Snr	Seriennummer Serial number	Zeigt die Seriennummer des Ejektors an Displays the serial number of the ejector
ctr	Luftsparfunktion Air-saving function	Einstellung der Luftsparfunktion Setting for the air-saving function
on	Luftsparfunktion ein Air-saving function on	Einschalten der Luftsparfunktion Activation of the air-saving function
onS	Luftsparfunktion ein mit Leckageüberwachung Air-saving function on with leakage monitoring	Einschalten der Luftsparfunktion mit Leckageüberwachung Switching on the air-saving function with leakage monitoring
off	Luftsparfunktion aus Air-saving function off	Ausschalten der Luftsparfunktion Deactivation of the air-saving function
dcS	Dauersaugen deaktivieren Deactivate continuous suction	Freigabe des Dauersaugens Enabling continuous suction
on	Dauersaugen deaktiviert Air-saving function on	Auswahl Dauersaugen ist deaktivieren Activation of the air-saving function
off	Dauersaugen ist aktiviert Air-saving function off	Auswahl Dauersaugen ist aktivieren Deactivation of the air-saving function
t-1	Evakuierungszeit Evacuation time	Einstellung der maximal zulässigen Evakuierungszeit Setting for the maximum permitted evacuation time
-L-	Leckagewert Leakage value	Einstellung der maximal zulässigen Leckage Setting for the maximum permitted leakage
blo	Abblasfunktion (blow off) Blow-off function	Menü zum Konfigurieren der Abblasfunktion Menu for configuring the blow-off function
-E-	Abblasen „Extern“ “External” blow-off	Auswahl extern gesteuertes Abblasen (externes Signal) Selection of externally controlled blow-off (external signal)

	Abblasen „Intern“ “Internal” blow-off	Auswahl intern gesteuertes Abblasen (intern ausgelöst, Zeit einstellbar) Selection of internally controlled blow-off (triggered internally; time can be set)
	Abblasen „Extern zeitgesteuert“ “Externally time-controlled” blow-off	Auswahl extern gesteuertes Abblasen (extern ausgelöst, Zeit einstellbar) Selection of externally controlled blow-off (triggered externally; time can be set)
	Konfig. Signalausgang Config. Signal output	Menü zum Konfigurieren des Signalausgangs Menu for Configuration of the signal output
	Schließerkontakt Normally open contact	Einstellung des Signalausgangs als Schließerkontakt Setting the signal output as a normally open contact
	Öffnerkontakt Normally closed contact	Einstellung des Signalausgangs als Öffnerkontakt Setting the signal output as a normally closed contact
	Konfiguration Signaltyp Config of signal type	Menü zur Konfiguration des Signaltyps (NPN / PNP) Menu for configuring the signal type (NPN/PNP)
	Signaltyp PNP PNP signal type	Alle Eingangs- und Ausgangssignale sind PNP-schaltend All input and output signals switch according to PNP
	Signaltyp NPN NPN signal type	Alle Eingangs- und Ausgangssignale sind NPN-schaltend All input and output signals switch according to NPN
	Vakuumeinheit (unit) Vacuum unit	Vakuumeinheit, in welcher der Messwert und die Einstellwerte angezeigt werden Vacuum unit in which the measurement and setting values are displayed
	Vakuumwert in mbar Vacuum value in mbar	Die angezeigten Vakuumwerte haben die Einheit mbar. Shown Vacuum values in mbar
	Vakuumwert in kPa Vacuum value in kPa	Die angezeigten Vakuumwerte haben die Einheit kPa. Shown Vacuum values in kPa
	Vakuumwert in inHg Vacuum value in Hg	Die angezeigten Vakuumwerte haben die Einheit inHg. Shown Vacuum values in Hg
	Ausschaltverzögerung Switch-off delay	Einstellen der Ausschaltverzögerung für OUT2 Setting for the switch-off delay for OUT2
	Rotation Display Rotation display	Einstellung der Displaydarstellung (Drehung) Setting of the Display Rotation
	Anzeige Standard Display Standard	Display nicht gedreht Display not rotated
	Anzeige gedreht Display rotated	Display um 180° rotiert Display rotated 180°
	ECO-Mode ECO-Mode	Einstellen des ECO-Mode Setting the ECO-Mode
	ECO-Mode an ECO-Mode on	ECO-Modus aktiviert – Display schaltet ab ECO-Mode activated – Display switches off
	Kein ECO-Modus No ECO-Mode	ECO-Modus deaktiviert – Display dauerhaft an ECO-Mode deactivated – Display on
	PIN-Code PIN-Code	Eingabe des Pincode zur Freigabe der Verriegelung Enter the PIN to unlock the menu
	Menü gesperrt (lock) Menu locked	Das Ändern von Parametern ist blockiert. A lock prevents parameters from being changed
	Menü entsperrt Menu unlocked	Die Tasten und Menüs sind freigegeben. The buttons and menus are unlocked.
	Reset Reset	Alle einstellbaren Werte werden auf Werkseinstellungen zurückgesetzt. All values that can be changed are reset to the factory settings.