



EN

Operating Instructions

Dust Filter STF...P / STF-D...P

Note

These operating instructions were written in the German language.
This document should be kept in a safe place for future reference.

The right to make technical changes is reserved. No responsibility is taken for printing errors or other types of errors.

Publisher

© J. Schmalz GmbH, 11.2014

This document is protected by copyright. J. Schmalz GmbH retains the rights established thereby. Reproduction of the contents, in full or in part, is only permitted within the limits of the legal provisions of copyright law. Any modifications to or abridgments of the document are prohibited without explicit written agreement from J. Schmalz GmbH.

Contact

J. Schmalz GmbH
Aacher Straße 29
D-72293 Glatten

Tel. +49 (0)7443 2403-0
Fax +49 (0)7443 2403-259
schmalz@schmalz.de
www.schmalz.com

Contact information for the Schmalz companies and trading partners, see
 www.schmalz.com/vertriebsnetz

Contents



Dust Filter STF...P / STF-D...P

1	Basic Safety Notes	4
1.1	Classification of Safety notes	4
1.2	Warnings	5
1.3	Signs.....	5
1.4	General Safety Notes	6
1.5	Intended use.....	6
1.6	Requirements for the user.....	7
2	Product Description	8
2.1	Versions.....	8
2.2	Dust filter with differential pressure monitoring STF-D...P	9
2.2.1	Technical Data differential pressure monitor.....	9
2.2.2	Principle of operation.....	9
3	Installation and Operation	11
3.1	General operation instructions	11
3.2	Installation position.....	11
3.3	Installation in the bracket.....	11
3.4	Mounting the hoses	12
4	Maintenance	12
4.1	Removing and cleaning filter inserts	12
4.2	Installing the filter cartridge	13
4.3	Spare and wearing parts	13
4.4	Put out of operation	13

1 Basic Safety Notes

1.1 Classification of Safety notes

Danger

This warning informs the user of a risk that will result in death or serious injury if it is not avoided.

 DANGER	
	<p>Type and source of the Danger</p> <p>Consequence</p> <p>▶ Remedial action</p>

Warning

This warning informs the user of a risk that could result in death or serious injury if it is not avoided.

 WARNING	
	<p>Type and source of the Danger</p> <p>Consequence</p> <p>▶ Remedial action</p>

Caution

This warning informs the user of a risk that could result injury if it is not avoided.

 CAUTION	
	<p>Type and source of the Danger</p> <p>Consequence</p> <p>▶ Remedial action</p>

Important

This warning informs the user of a risk that could result damage to property if it is not avoided.

IMPORTANT	
	<p>Type and source of the Danger</p> <p>Consequence</p> <p>▶ Remedial action</p>





Notice

This symbol is used when important notes and information regarding use of the machine/the system/the device are provided.

	<p>Information on the use</p>
---	-------------------------------

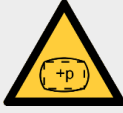

1.2 Warnings

Explanation of the warning symbols used in the operating instructions.



Warnings	Description	Warnings	Description
	General warning sign		Danger due to flying parts
	Warning against electric shock		Warning to overpressure
	Warning about dust generation		

1.3 Signs

Explanation of the mandatory symbols used in the operating instructions.

Signs	Description	Signs	Description
	Wear a mask		Use protective glasses
	Disconnect before servicing or repair		



1.4 General Safety Notes



 WARNING	
	<p>Ignoring the general safety guidelines Personal injuries / damage to plants / systems</p> <ul style="list-style-type: none"> ▶ The operating instructions contain important information on using the dust filter. Read the operating instructions thoroughly and keep them for later reference. ▶ Do not connect the filter or start operations until after you have read and understood the operating instructions fully. ▶ Use only the connections, mounting holes and attachment materials that have been provided. ▶ Carry out mounting or removal only when the device is in an idle, depressurized state. ▶ Only qualified specialist personnel, mechanics and electricians may perform the installation. Qualified specialist personnel are persons who have received technical training and have the knowledge and experience – including knowledge of corresponding regulations – necessary to enable him or her to recognize possible dangers and implement the appropriate safety measures while performing tasks. The same applies to maintenance! ▶ General safety regulations, European standards and VDE guidelines must be observed and complied with. ▶ It is not permitted to make changes to system components. ▶ Protect the components from damage of any kind.

1.5 Intended use

This dust filter is intended solely for filtering mechanical components in air. This device must not be used to filter other media or liquids.

The vacuum must not exceed -500 mbar. Overpressure is not permissible.

 WARNING	
	<p>Transport or through-suction of liquids or bulk material Personal injury and/or damage to property</p> <ul style="list-style-type: none"> ▶ Do not transport or suck through liquids or bulk material

 CAUTION	
 	<p>Pressure can cause closed devices to explode Personal injury and/or damage to property</p> <ul style="list-style-type: none"> ▶ Wear protective glasses

1.6 Requirements for the user

All personnel working with the product must be familiar with basic mechanical and pneumatic principles as well as the appropriate technical terminology.

To ensure safe operation, this work may only be performed by qualified personnel or trained persons working under the supervision of qualified personnel.

“A qualified employee is defined as an employee who has received technical training and has the knowledge and experience – including knowledge of corresponding regulations – necessary to enable him or her to recognize possible dangers and implement the appropriate safety measures while performing tasks. Qualified personnel must observe the pertinent industry-specific rules and regulations.”

2 Product Description

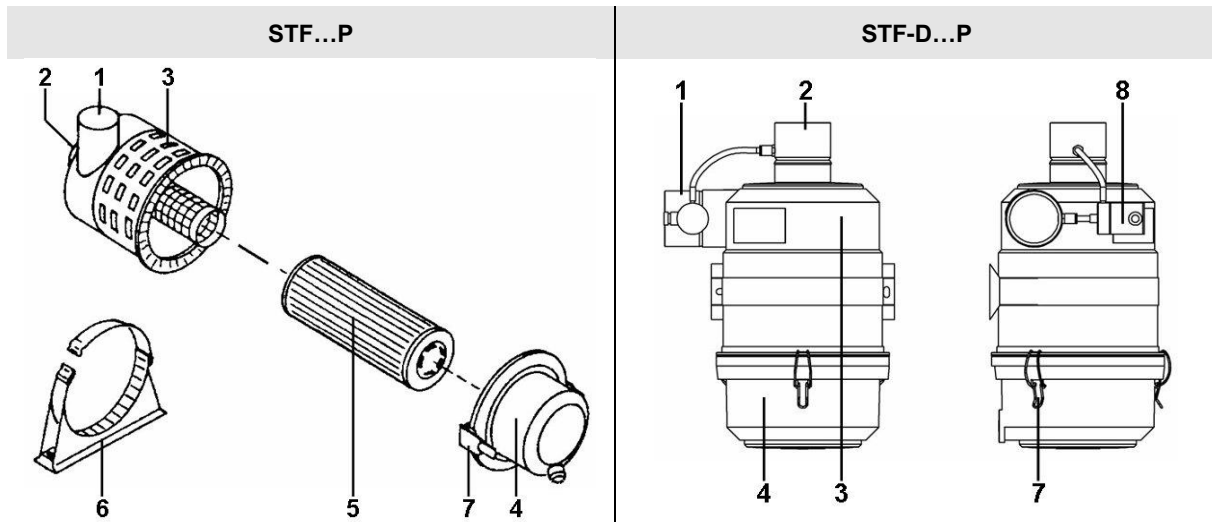

2.1 Versions

The dust filters are available in the basic version STF...P and in the version with differential pressure switch STF-D...P.



Pos.	Designation
1	Air inlet connection (suction pad)
2	Air outlet connection (vacuum generator)
3	Upper housing section
4	Lower housing section (dust collecting pan)
5	Filter insert
6	Bracket with locking clip
7	Clamp
8	Differential pressure monitor, adjustable

2.2 Dust filter with differential pressure monitoring STF-D...P

 DANGER	
 	<p>Electric shock Fatal injury</p> <ul style="list-style-type: none"> ▶ Disconnect the system from the power supply when connecting or setting the differential pressure monitor. ▶ Only operate the system when the differential pressure monitor is properly fitted with a protective cap.

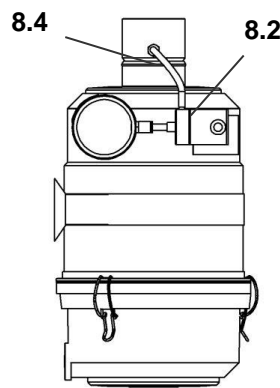
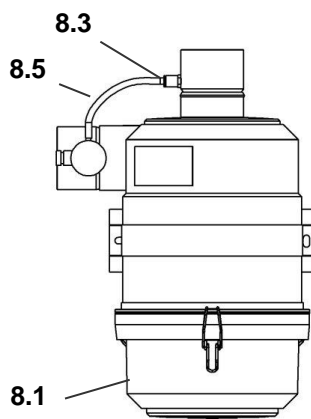

Pos.	Designation
8.1	Dust filter STF-D...
8.2	Differential pressure monitor
8.3	Plug in screw union STV 1/8"-6/4
8.4	Hose
8.5	Hose

2.2.1 Technical Data differential pressure monitor

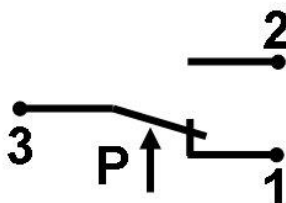
Differential pressure range	10...50 mbar	
Accuracy	±10%	
Hysteresis	5 mbar	
Maximum operating pressure	100 mbar	
Contact switching capacity	250 V AC / 6 A 24 V DC / 1 A	
Electrical connections	AMP-Flachstecker 6,3 mm x 0,8 mm nach DIN 46244	
Approval	VDE 0630	

2.2.2 Principle of operation

The differential-pressure monitor (Pos. 2) continuously measures the pressure drop across the dust filter.

This pressure drop increases as the filter becomes dirty.

The limit value for the differential pressure can be adjusted with a knurled knob to any desired value between 10 and 50 mbar.

When this limit value is exceeded, contact of the differential-pressure monitor is actuated. Thereby, the cleaning of the dust filter can be signaled.

Configuration without indicator lamp

The switching signal (normally open or normally closed) initiates signal processing provided by the customer. This signal disappears again when the pressure drops below the limit value (for example, after cleaning or replacement of the filter cartridge).

Configuration with indicator lamp

The differential-pressure monitor switches on the indicator lamp when the pressure drop across the filter exceeds the limit value. The lamp is switched off again when the pressure drops below the limit value (for example, after cleaning or replacement of the filter cartridge).



The indicator lamp indicates that the cleaning/replacement of the filter cartridge is recommended.

3 Installation and Operation

3.1 General operation instructions

- The temperature must be between -40 °C and +80°C
- The filter must be watertight
- Warm air should not be drawn in
- The unit must be easily accessible. (checks, cleaning and replacing the filter insert)



With the Jumbo hose lifter, holes for mounting the filter are located on the components used for blower attachment.

3.2 Installation position

- The bracket is attached using 2 screws.
- The dust filter can be installed vertically or horizontally. When mounting the unit vertically, note that the dust collecting system [4] must be at the bottom



Incorrect installation means that the dust filter and vacuum generator are no longer under warranty.

3.3 Installation in the bracket

- Place the filter in the bracket [6] and turn or slide in to the desired installation position.
- Close and lock the locking clip
- When mounting the unit horizontally, make sure that the "Oben / Top" marking is at the top (+/- 15° deviation is permissible)
→ If necessary, remove the lower housing section, turn it and reattach.

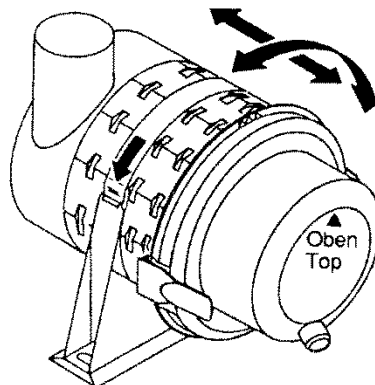

3.4 Mounting the hoses





- Filter connections are optimised for the inner diameter of the vacuum hoses.
- Hoses are attached using the SSD hose clamps included in the delivery

4 Maintenance

 DANGER	
	<p>Damage from vacuum generator that has not been switched off</p> <p>Personal injury</p> <ul style="list-style-type: none"> ▶ Switch the vacuum generator (e.g. blower, pump) off when performing cleaning, maintenance and repair work.

Component	Task	Time of maintenance
Filter insert	Clean and check for damage	According to the operating instructions of the connected devices
	Replace	At least once after 5 cleanings or at least once every 2 years
Connection hoses	Check for damage and leaks	Monthly or after repairs have been conducted
Plastic housing and bracket	Check for damage and tears	Check when performing filter maintenance

4.1 Removing and cleaning filter inserts

 WARNING	
  	<p>Whirling dust particles</p> <p>Damage to eyes and respiratory tract</p> <ul style="list-style-type: none"> ▶ Wear protective glasses ▶ Wear respiratory protection

- Open the housing using the clamp [7]. The dust collecting pan [4] has to be at the bottom.
- Remove the filter insert [5] from the housing.
- Do not wash or brush the filter insert, blow it.
- Make sure that no dust can get into the inside of the filter insert during blowing.
- For cleaning, attach a compressed-air pistol with an attached pipe, the end of which is bent approx. 90°. It must be long enough to reach the bottom of the insert. Inserts must be blown from the inside out using dry pressurised air (max. 5 bar) long enough to prevent dust formation.

4.2 Installing the filter cartridge

- Before installation, the clean filter cartridge must be checked for damage to the paper bellows and the rubber gaskets.
- Damaged filter inserts must not be re-used. In case of doubt, install a new filter insert.
- Insert the filter insert and close the housing using the clamp [7].

4.3 Spare and wearing parts

We accept liability for this unit pursuant to our General Terms and Conditions of Sale and Delivery. The same applies for spare parts, provided that these are original parts supplied by us. We fully exclude liability for any damages arising from use of spare parts or accessories that are not original parts of accessories.

Designation	Use	Art.-No.	Legende
Jumbo Filter insert	Jumbo hose lifter	11.04.03.10086	W
Filter insert 4.5	STF ... 4.5 ...	10.07.01.00060	W
Filter insert 6.0	STF ... 6.0 ...	10.07.01.00054	W
Filter insert 8.0	STF ... 8.0 ...	10.07.01.00079	W
Filter insert 24.0	STF ... 24.0 ...	10.07.01.00083	W
Hose clamp SSD60	STF ... 4.5 ... / STF ... 6.0 ...	10.07.10.00017	S
Hose clamp SSD76	STF ... 8.0 ...	10.07.10.00037	S
Hose clamp SSD125	STF ... 24.0 ...	10.07.10.00052	S
Differential pressure monitor	STF-D ... F	21.01.06.00011	S

S= Spare part, W= Wearing part

4.4 Put out of operation

The system, replaced components or assemblies must be disposed after the exchange or the shut down, according to national guidelines.

IMPORTANT	
	<p>Incorrect disposal of the dust filter</p> <p>Environmental damage</p> <p>▶ Disposal according to country-specific guidelines</p>

Schmalz Services



Global contact

Our sales network of local field representatives, international subsidiaries and trade partners ensures quick and competent information and advice in more than 50 countries worldwide.

 www.schmalz.com/vertriebsnetz



Online dokumentation

Conveniently download catalogs, operating instructions and CAD data and get comprehensive information about our products and services.

 www.schmalz.com/dokumentationen



„How-to“ videos

In short, easy-to-understand videos we explain the comprehensive functions offered by our products. Take a look, it's worth it!

 www.schmalz.com/gewusst-wie

Other services from consulting to training, see

 www.schmalz.com/services